

Alchemy TV DVR

User Guide



Table of contents

Introduction and Overview of AlchemyTV DVR	1
Introduction and System requirements	2
Overview of AlchemyTV DVR	3
Hardware and software installation	5
Hardware installation	6
Software installation	7
Setting up the TV tuner for viewing and recording	11
Introduction	12
Serial Number and Registration	12
Setting up AlchemyTV DVR for TV reception	12
Using the AlchemyTV DVR Menus and Onscreen Remote	15
AlchemyTV DVR Menus	16
AlchemyTV DVR Onscreen controller	18
Using the AlchemyTV DVR Preferences	22
AlchemyTV DVR preferences overview	23
The Storage menu	24
The Video input menu	25
The image sub-menu	26
The Video compression sub-menu	27
The Video compression Expert settings	27
The Size sub-menu	28
The Audio sub-menu	29
The Audio Expert settings	29
The TV Tuner sub-menu	31
The plugins menu	33
Scheduling a recording with AlchemyTV DVR	34
Schedule a recording with AlchemyTV DVR	35
iCal Synchronisation	38
Scheduling a recording with TitanTV	39
Registering with TitanTV	40
TitanTV plug-in settings	40
Scheduling a recording	41
Plug-ins	42
AlchemyTV DVR SDK	43
Installing Third-Party Plug-ins	43
Using the Plug-ins	44
Current Plug-ins	45
The infrared remote control	47
The remote control settings	48
QuickTime Codecs	51
Recommended codecs	52
Third party codecs	52
License agreement	53

Introduction and Overview of AlchemyTV DVR

Introduction

Thank you for choosing AlchemyTV DVR™ from Miglia Technology. AlchemyTV DVR™ allows you to watch TV on your PowerMac and enables you to record your favorite programmes onto your hard drive in a supported QuickTime format of your choice.

System requirements:

- PowerMac G4 or G5 with a free PCI or PCI-X slot
- G4/400 MHz or higher processor
- 256 MB of RAM
- Mac OS X 10.3.x or higher
- QuickTime 6.5.x or higher

Package contents

- AlchemyTV™ DVR card
- CD-ROM with software and installation guide
- Infrared remote control
- Infrared remote control receiver
- Warranty card

User Guide Overview

This User Guide will guide you through the hardware and software installation as well as explain the functions and options of the AlchemyTV DVR™ software.

Technical Support

Should you ever have any questions regarding your product, please do not hesitate to contact Miglia Technology:

Miglia Technology Ltd

Unit 1, The Old Silk Mill

Brook Street

Tring

HP23 5EF

United Kingdom

Tel: +44 870 747 2988

Fax: +44 870 747 2989

E-mail: info@miglia.com, for general enquiries

support@miglia.com, for technical enquiries

Web: <http://www.miglia.com>

Overview of AlchemyTV DVR™

Video inputs

AlchemyTV™ features several video inputs:

- TV input
- Composite input
- S-Video input
- Stereo audio input (jack type)
- Stereo audio output (jack type)

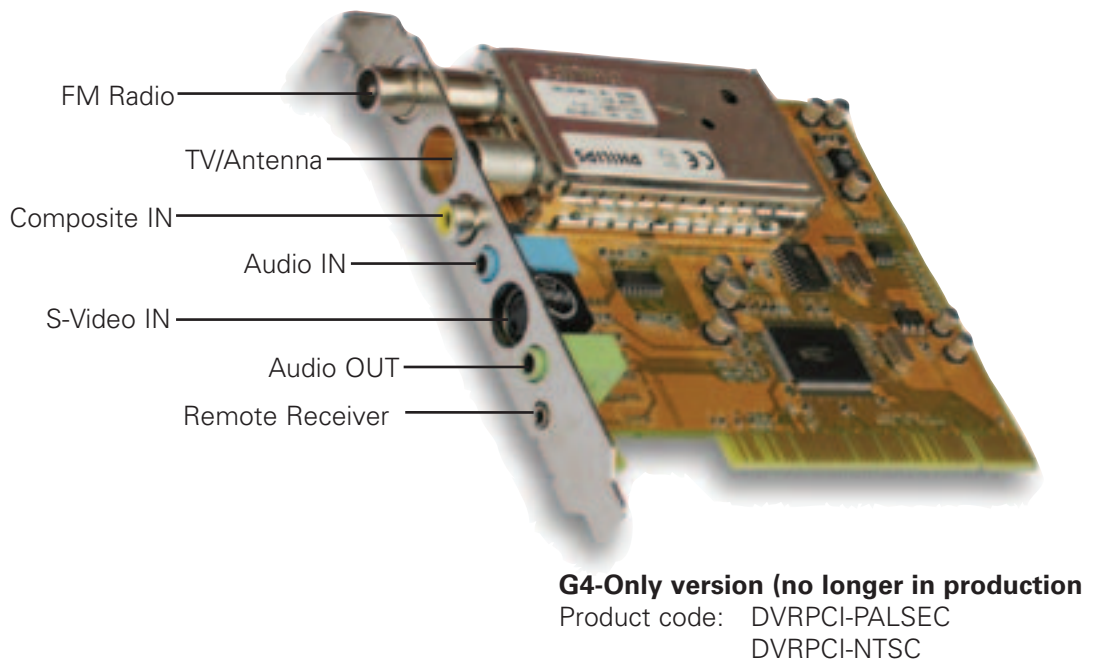
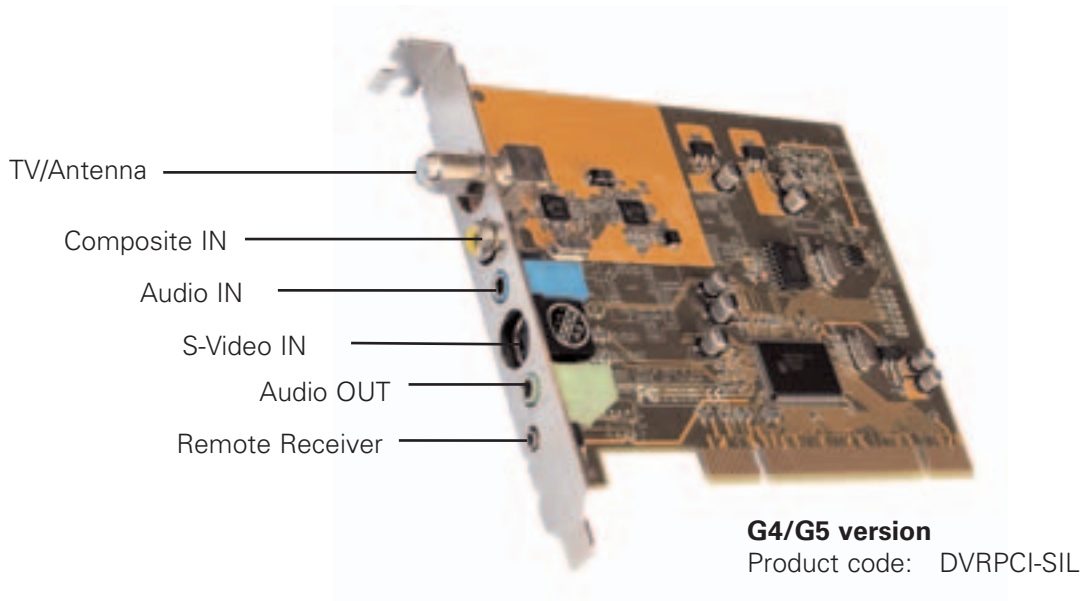

- **TV/Antenna connection:** This connector should be used for your analogue TV cable coming from an RF antenna or a cable box.
- **FM Connector:** This connector is available solely with the G4-only version of the card. It allows you to connect an FM antenna.
- **Composite input:** Composite is a widely used standard for connecting video equipment. Note that the quality of this connection is not as good as S-Video. This type of connector is often found on camcorders and VCRs.
- **S-Video input:** This connection gives a better image quality than composite and is generally found on mid-range camcorders, VCRs and DVD players. If you intend to capture video from an analogue source, use this connection whenever you can.
- **Stereo audio IN:** The AlchemyTV™ card uses a conventional stereo jack plug
- **Stereo audio OUT:** The AlchemyTV™ card uses a conventional stereo jack plug to output audio to external speakers. This connector is a pass-through only and cannot be used as an audio output with other applications.
- **Remote receiver:** This connector is used to connect the IR receiver for the AlchemyTV DVR remote control.

Hardware and Software Installation

I. Hardware Installation

The installation of AlchemyTV™ is a two step process starting with the hardware installation into your PowerMac. AlchemyTV™ is a PCI card that should be installed in a free expansion slot of your Mac.

Makes sure you are wearing an anti-static wrist wrap before beginning the installation.

PowerMac G4

1. Shut down your Mac and open the side door of your PowerMac. Locate an unused PCI slot. Using a small Phillips-head screwdriver, remove the retaining screw from the PCI expansion slots access panel, then remove the access panel itself.

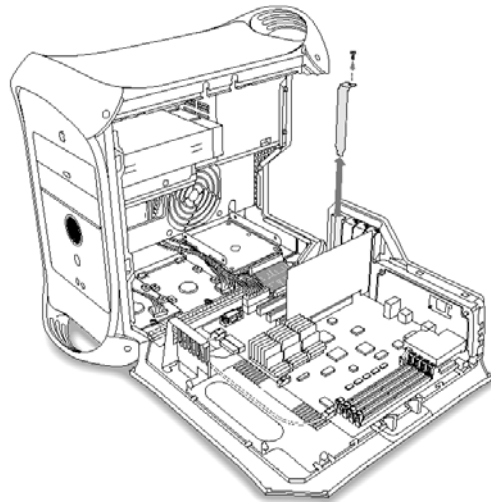

2. Align the connector end of the card with the PCI expansion slot and insert the card. Secure the card with the screw that you removed in the previous step.

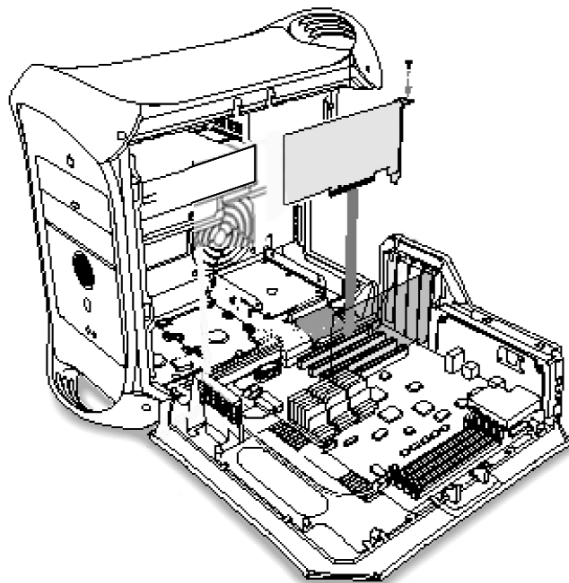

PowerMac G5

1. Shut down your Mac. Remove the side panel and plastic door of your PowerMac. Locate an unused PCI slot. Using a small Phillips-head screwdriver, remove the retaining screw from the PCI expansion slots access panel, then remove the access panel itself.

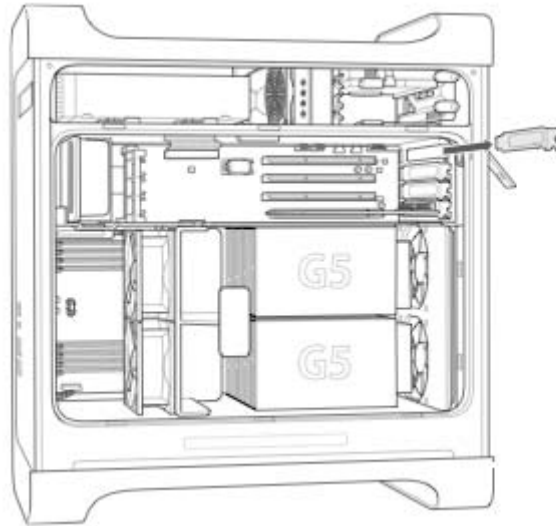

2. Align the connector end of the card with the PCI slot and insert the card. Secure the card with the screw that you removed in the previous step.

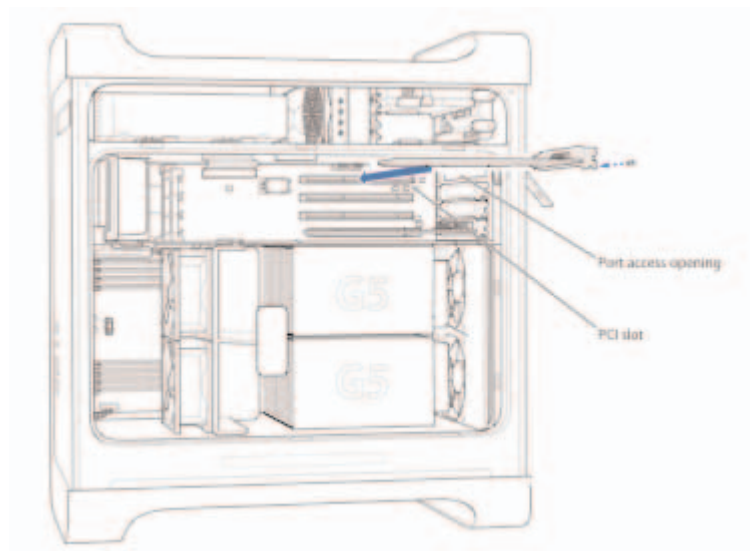

3. Close the plastic cover and side panel. Start your PowerMac and proceed to the software installation step.

Remote Installation:

Connect the remote control receiver cable to the RM port on the AlchemyTV card. Make sure the plug of the cable rests on the PCI card and not the metalwork of the case.



Note that the infrared remote control has a plastic separator between the battery and the electric contacts. Remove it to operate the remote.

II. Software Installation

1. Insert the Installation CD that shipped with your AlchemyTV DVR™ card into your CD/DVD drive.
2. Before installing the version available on the CD, it is recommended that you check any available updates on the Miglia site. Double-click on the icon named 'Click here to check if a newer version is available' to access the website page.
3. Open the folder AlchemyDVR and double-click on the "Install AlchemyTV DVR™" icon to launch the installer. Select the startup drive of your choice and click on 'Install'. Note that you will be asked for your administrator password when performing the installation.



4. Once the installation process is finished, restart your Mac.
5. If you are using two AlchemyTV cards in your system, you will need to launch the 'Install Multiple Card Support' installation application. An enhanced driver will be installed into your system folder.

Note: If you own a FireWire webcam and wish to use iChat AV, install the AlchemyTV ichat patch located on the first level of the CD. This will avoid error messages in iChat rendering your webcam unusable. The iChat patch requires Application Enhancer to be installed first. A link to a download page is provided on the CD.

- The AlchemyTV DVR folder will be located in the 'Applications' folder of the volume containing your system software.

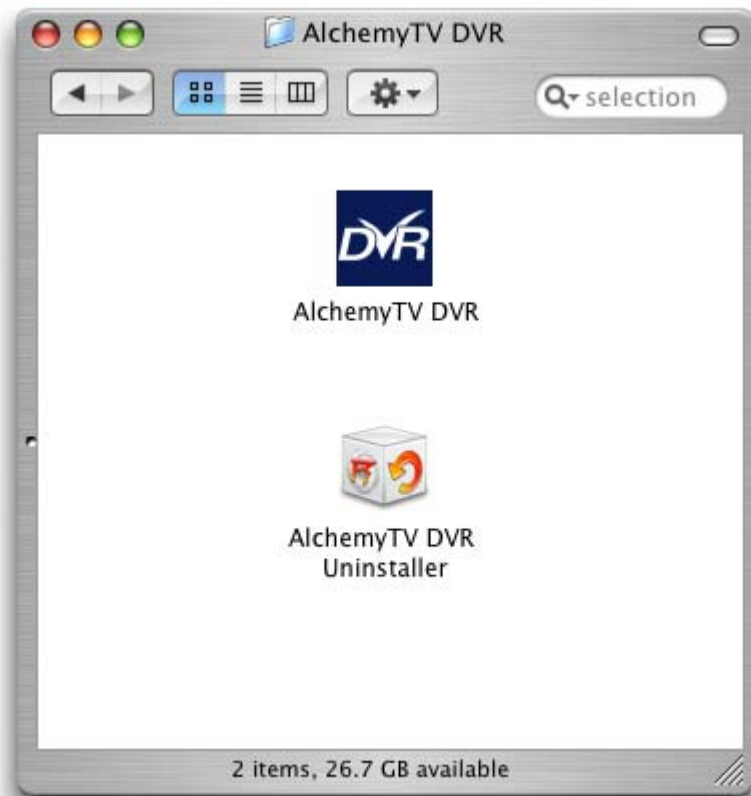

- Note that the control panel "Remote Control" is also added to the System Preferences panel.



If you have installed the Application Enhancer (for the iChat patch), the APE manager will also appear.

- The installation log is located in: <Username> / Library / Logs

*Setting up AlchemyTV DVR
for viewing and recording*

Introduction

This chapter will guide you through the initial setup of the AlchemyTV DVR card and software. Before proceeding, make sure you have installed the PCI card and the software and connected your video source via the composite or S-Video or coaxial connectors.

I. Serial Number and Registration

1. Launch AlchemyTV DVR located in your Applications folder
2. You will be asked to enter your serial number located on the CD sleeve or the CD itself. Enter the 32 digits serial number with the dashes as shown below:
XXXX-XXXX-XXXX-XXXX-XXXX-XXXX-XXXX-XXXX

II. Setting up AlchemyTV DVR for TV reception

The Setup Assistant will launch automatically on the first startup of the software. You can access it at anytime via AlchemyTV DVR > Setup Assistant
The AlchemyTV DVR Setup Assistant will guide you through the set up process and create a list of settings based on your choices and hardware configuration.

1. Start by selecting your country. If your country is not in the list, select the relevant TV standard via the 'Other' option.



2. The Setup Assistant will ask you to choose the type of connection you are using.
If you connect your card directly to an antenna or a cable TV outlet, choose the 'TV Tuner' option.
If you are subscribing to a premium or digital cable service or digital satellite, it is recommended that you make a connection via S-Video. This will ensure the best quality possible. Channels will have to be switched via the remote control of your cable or satellite receiver.
If you are using AlchemyTV DVR for video capture from a VCR, camcorder or DVD player, choose either composite or S-Video.
Then Click Next



3. **Composite or S-Video Connection**
If you have selected TV Tuner as the input, please skip to step 6.
Select the audio input based on your connection. You will most likely use the audio in on the AlchemyTV™ card or built-into your PowerMac.
Click on Next and skip to step 5

USA residents only

If you have selected TV Tuner as the input connection, the Setup Assistant will ask you to enter your ZIP code to download the relevant channel naming templates from TVGuide.com. This will prevent you from having to give names manually to the individual channels.

4. **TV Tuner Connection:**

Press the 'Start Scan' button to start the automatic channel search.

You will be given three options during the channel scan:

Get all Channels: The software will scan and store all channels without interruption until the process is complete. This option will not allow you to name individual channels and some channels with poor reception may be stored. Naming and deleting stations can be performed at a later stage in the preference menu.

Ignore Channel: When the software finds a channel, it will be displayed in the preview window leaving you the decision to store or discard it. By clicking ignore, you skip a channel and enable the scan to continue.

Next Channel: Once a channel is found you can enter a name (this is optional) and press 'Next Channel' to store it and continue the scan. Repeat the operation until all channels are found. The Assistant automatically moves to the next

5. Once this operation finished, the Setup Assistant will create video compression and display settings based on the performance of your computer. These settings can be modified at a later stage by using the Preferences submenu.
6. If you wish to view live TV, you can open the TV window via the View menu.

Using the AlchemyTV DVR Menus and Onscreen Remote

I. AlchemyTV DVR Menus

Various functions are accessible via the menu bar:

1. **The AlchemyTV DVR Menu** lets you access:
 - About box: Displays about box with version number
 - Setup Assistant: Launches the Setup Assistant
 - Register: Open the Registration dialog
 - Software Update: Checks online if a new version is available. This check is also performed automatically at launch if an internet connection is open.
 - Hide/Show/Quit: Standard Hide, show and quit options.

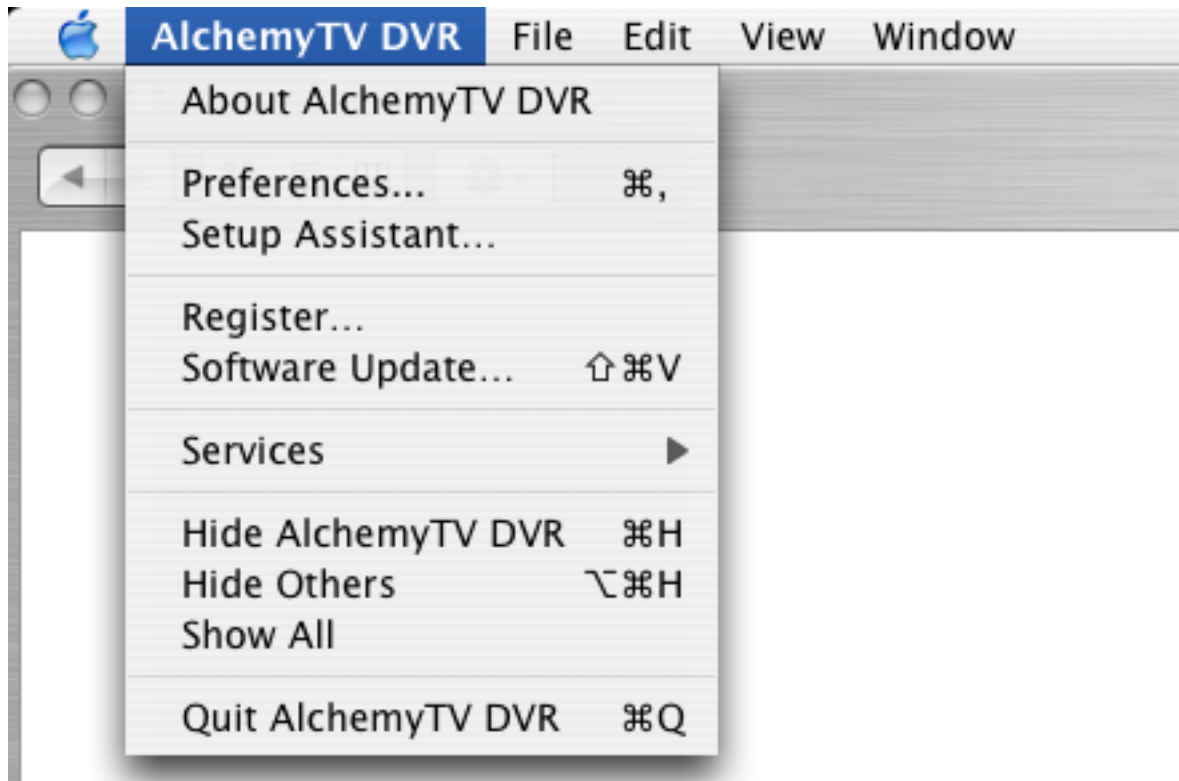

2. **The File menu** enables you to close the foremost window.
3. **The Edit menu** contain the standard OS provided options and the controller shortcuts.
 - Channel Up/Down: Only applicable if you are using the TV tuner as the video input. Switches one TV channel up
 - Volume UP/Down: Increases or decreases the volume
 - Mute: Mutes the audio
 - Record: Records the video currently displayed
 - TV Snapshot: Creates a snapshot of the video currently displayed in the TV window.
 - Delete Finished Recording: Deletes the completed recordings in the Scheduled Recording window
 - Clear Log: Clears the recordings log.

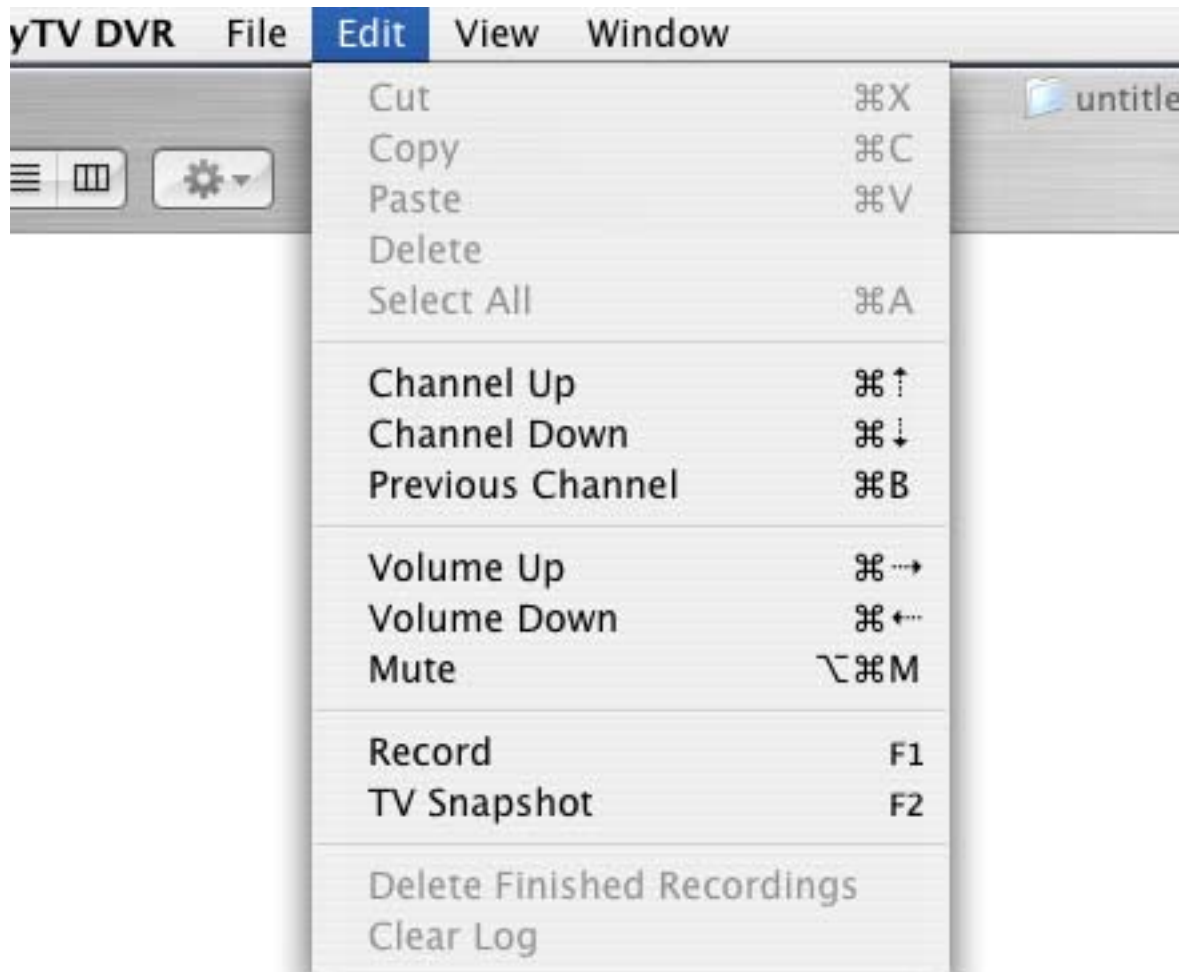

The Edit Menu

4. **The View Menu** contains the video related commands.

Scheduled Recordings: Open the scheduled recordings window. Enables timed recordings.

Log Window: The log window contains a report for each finished or aborted scheduled recording.

TV Window: Displays the live TV window

TV Window Size: Contains 3 pre-defined sizes, quarter, half and full size. The Full Screen option will hide all other applications and display the video in full screen mode.

Controller: Displays the onscreen controller

FM Radio: Open the FM radio remote. This option is only provided for backward compatibility with older hardware models of the AlchemyTV DVR (G4-only)



The View Menu

5. **The Window menu** contains a shortcut to the full screen mode (Zoom) and enables you to switch between open windows.
6. The Help menu contains a link to the Miglia supportweb page and allows to open this manual.

II. AlchemyTV DVR Onscreen controller

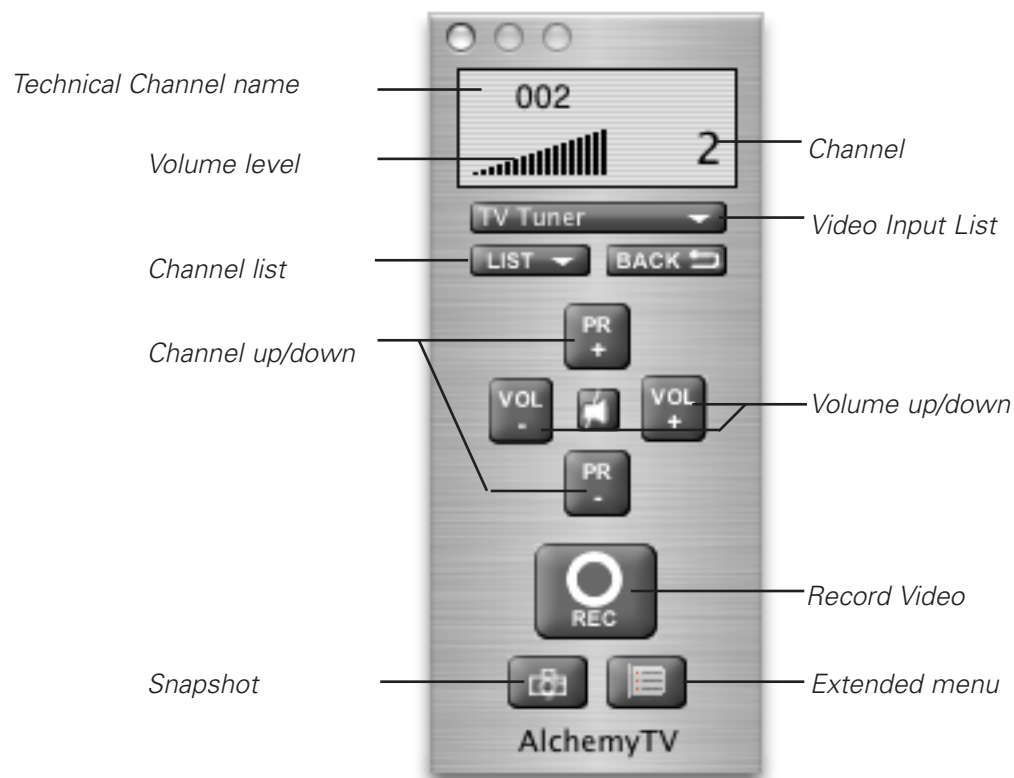

1. Basic Remote Functions

Technical Channel:	Displays the technical channel number
Volume level:	Displays the volume level selected in the software
Channel List:	Shows a list of all stored/saved TV channels
Channel Up/Down:	Switches channels up and down
Snapshot:	Stores a snapshot of the picture currently displayed in the TV window
Channel:	Displays the channel number as per the TV tuner channel list
Video input list:	Displays the four possible video inputs. Enables easy switching between video inputs (TV and composite for example). Note that Composite over S-Video is used for SCART-To-S-Video cables only.
Volume up/down:	Increases or decreases the output volume
Record Video:	Starts an instant record of the video currently displayed in the TV window
Extended menu:	Opens the extended controller, which contains additional controls

2. Extended Remote Functions

The extended remote has two sections: Image Settings and Video Source.

Image Settings:

In this section, you can adjust the various image controls, eg. Hue, Saturation, Contrast, Brightness, Sharpness. The setting for picture deinterlacing is also available with four options: None, Basic, Normal, Best. Deinterlacing will affect the picture quality on fast moving footage. Note that you will need a G4/1GHz or higher to use the 'Best' Setting.

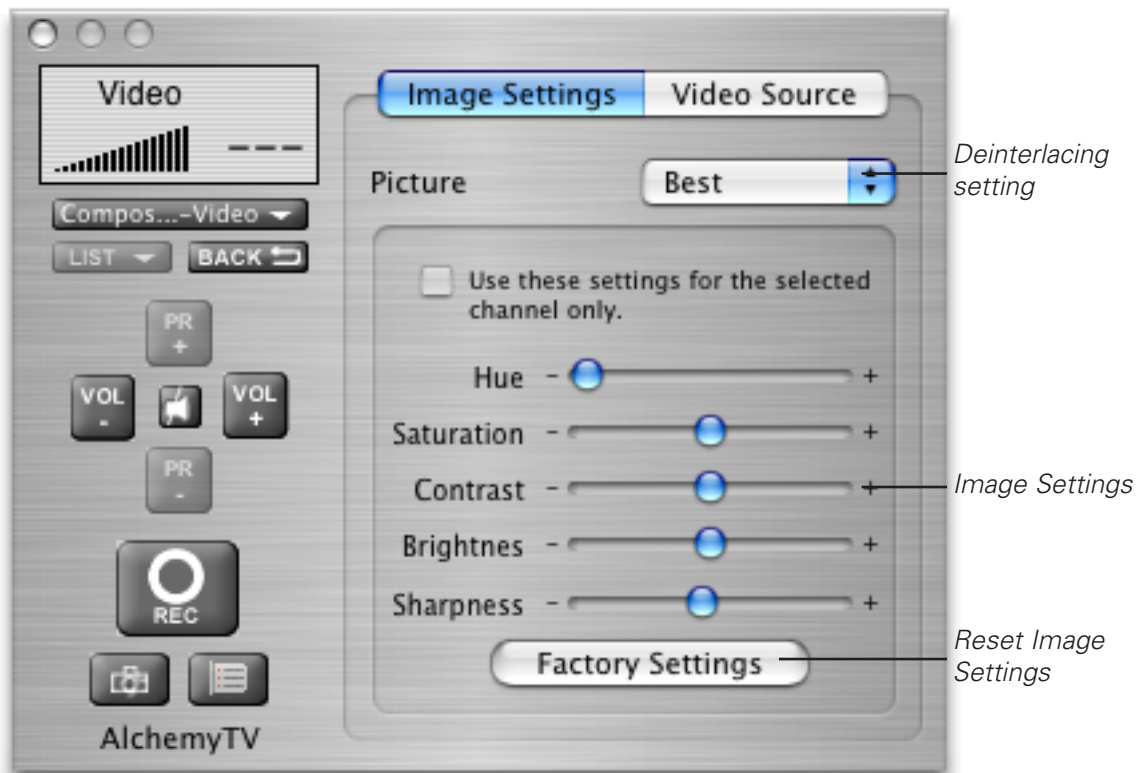

Video Source Settings:

This panel allows you to adjust the video source settings:

- Device: Enables you to select the desired video input device. This will most likely be AlchemyTV
- Format: Enables you to select the video standard. US, Canada and Japan residents should use 'NTSC', while most European users should select 'PAL'. French and Eastern European users should select 'SECAM'.
- Use Channel Name as Index: This option is important for US residents. It will align the technical number of channels with their position in the stored channel list.



Window Settings:

The Window pane enables you to activate three options:

Always in front: The TV window will always be in front of all other applications.

Transparency: Enables you to adjust the level of transparency for the TV window.

Clip edges: The option to clip the edges enables you to reduced the viewable area of the picture. This is helpful if you are watching a widescreen movie or the TV picture displays a line at the top (due to closed captioning). Four presets enable you a quick access to the most common settings. A custom value can be entered by selecting 'Custom' in the presets.

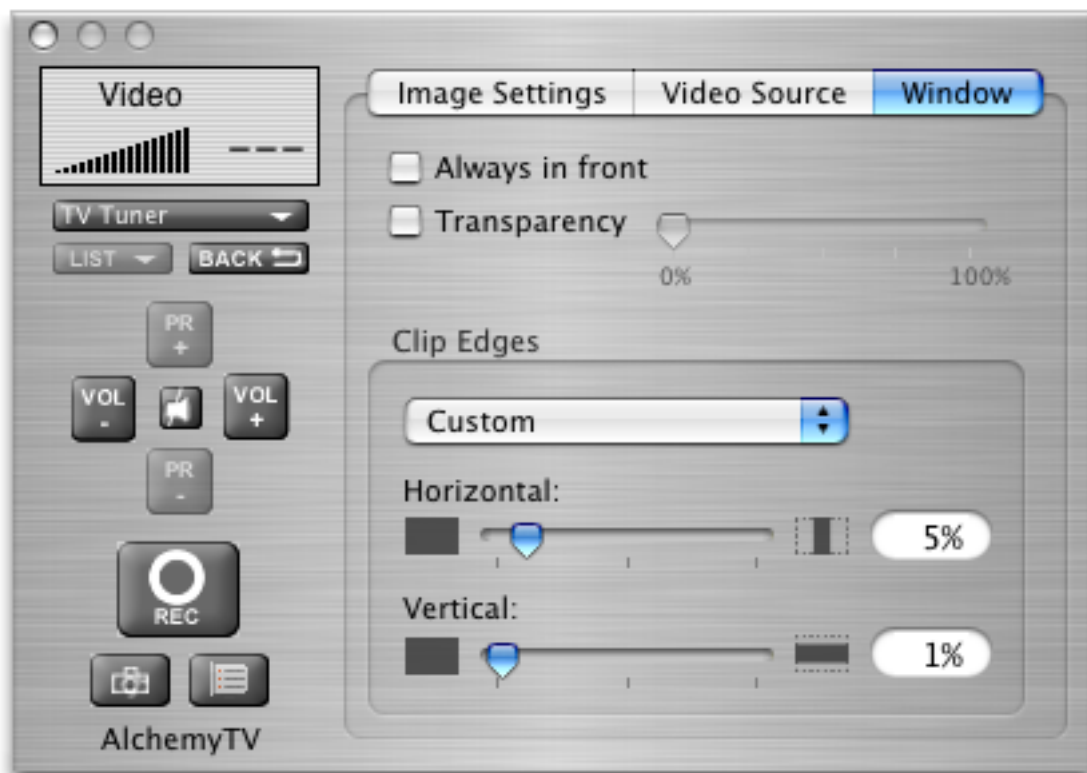

Using the AlchemyTV DVR Preferences

I. AlchemyTV DVR preferences overview

1. Select AlchemyTV DVR > Preferences

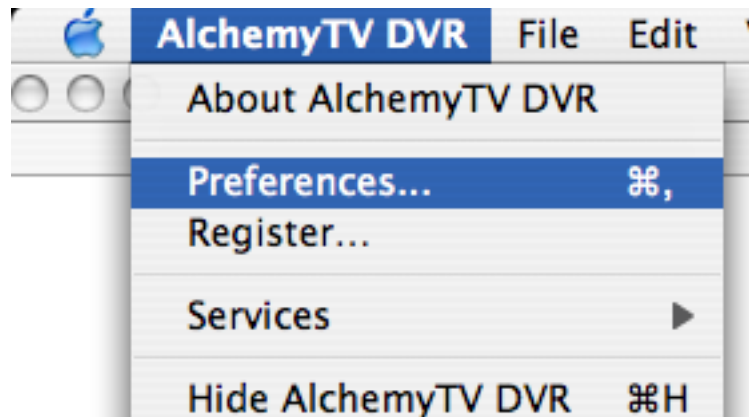

1. The preferences are divided in four categories:

- Storage:** This category allows you to set the general storage preferences
- Video Input:** This menu allows you to set all video and audio preferences. Advanced settings are available via standard QuickTime sub-menus.
- Plugins:** AlchemyTV DVR supports a Plugins architecture for a smooth integration with other applications or devices.

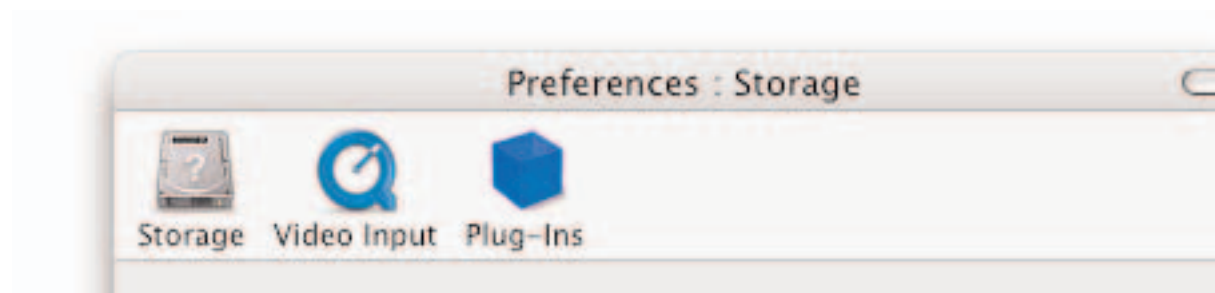

I. The Storage Sub-menu

1. The Storage tab contains three important options:
Filename Templates: Name templates used for your recorded video files
2. **The Filename Template** allows you to enter pre-defined values for the name of the file that will be stored onto your hard drive.
<input>: This value will add the input type (AlchemyTV) to the filename
<channel>: This value will add the channel frequency to the filename
<name>: This will add the channel name to the filename
<program>: This will add a text string that can be chosen when adding a recording

Filename templates are useful when scheduling repeated recordings. If you could schedule a recording every day of the week, the template will make sure that you do not erase the previous day's recording.

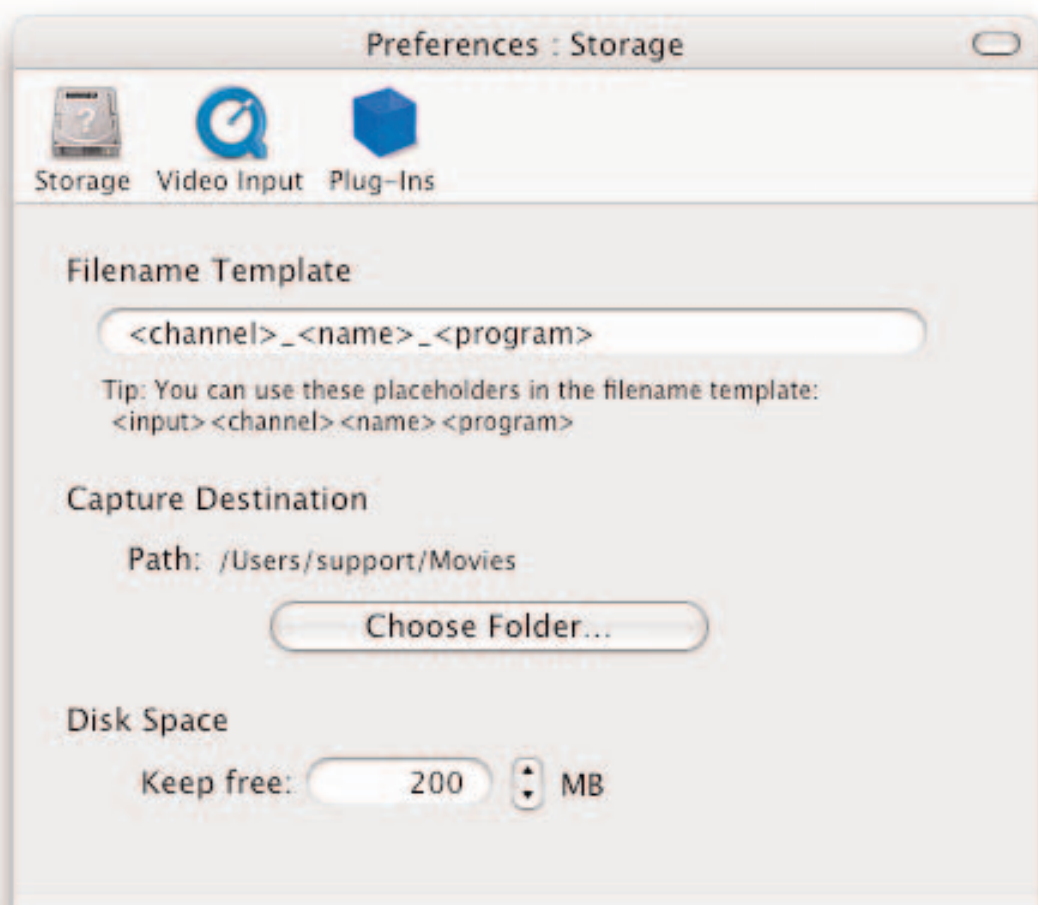

3. The capture destination menu enables you to select where you wish to store your recorded video. Click the 'Browse' button to modify this location.
4. The disk space option allows you to keep a defined amount of space free on your hard drive.

Note: This is very important if you are capturing to the hard drive where your System Folder is located. Should your boot drive be full, you might not be able to startup your Mac. This setting will override your scheduled recordings should the drive reach the defined free space limit.

II. The Video Input Menu

The Video Input menu contains the most important controls you have over the video you will view or record to your hard drive.

A. Adjusting the video settings

1. **The image sub-menu** allows you to control the brightness, lighting, saturation and hue of the recorded video. Adjustments can be made by moving the sliders or entering a value on the right hand side. If you wish to perform an adjustment on a single channel, display it in the preview window by selecting it in the Tuner sub-menu and ticking the box 'Use these settings for the selected channel only'.

The image sub-menu also contains the Picture Optimization feature that controls de-interlacing. This functionality reduces or removes the small interlace lines you may see on fast moving footage (camera pan for example). Although the Setup Assistant will have determined the optimum setting for your PowerMac, you can change it via the drop-down menu.

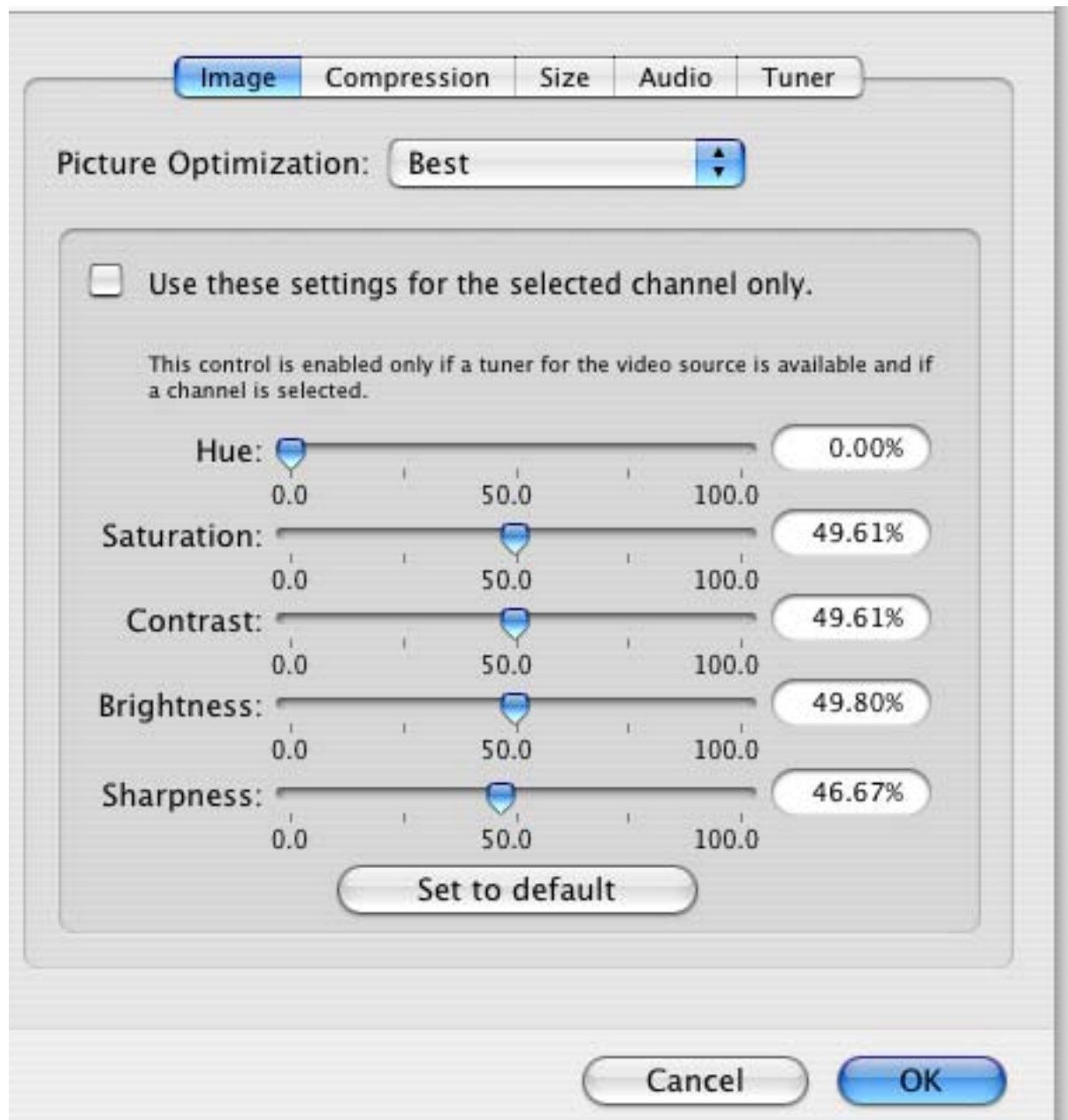

2. **Video Compression** will adjust the video codec and quality settings for the video you will record to your hard drive.

Select the QuickTime codec of your choice in the drop down menu. The options are identical to those you would choose for AlchemyTV. The 'Expert settings' allow you to access the QuickTime video motion menu.

Note: This option will also affect the video you record via the TV window and the scheduled recordings.

For more information about the various codecs, please refer to the chapter "QuickTime Codecs"



3. **The Video Compression Expert Settings menu** may be familiar to you. It is a standard QuickTime window you may have seen in other applications. It enables an advanced control over the QuickTime codecs.



Some Codecs may have advanced settings available under the codec list. This is notably true for MJPEG and some third-party codecs.

This codec list can be expanded by installing third party codecs like DivX and 3ivX. Note that no third party codec is supported at the time of this writing, but DivX and 3ivX have produced some good results in early testing. Please review <http://www.miglia.com/Support/alchemytvdvr.html> for updated information.

Via the **Motion sub-menu**, you can select the number of frame per second that should be recorded. The 'Best' option will automatically set the fps value at the maximum possible and is recommended.

You can force the software to create a **'key frame'** at a given value. Unlike normal frames, a key frame is not based on the previous frame and will increase the overall quality of your video. Having more key frames increases the size of the captured video.

It is possible to increase the compression rate of your video by limiting the **data rate**. Note that picture quality will suffer if the value is set too low. This value affects only the video track, not the audio track, there fore the final size of your movie will always exceed datarate x length of recording

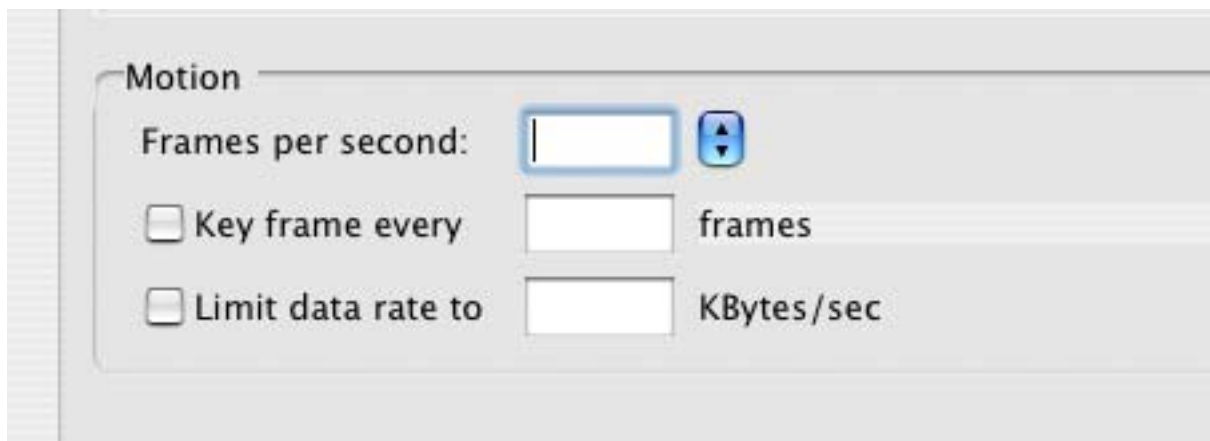

4. The Size Menu

The Video Size for scheduled recordings can be adjusted via this sub-menu. You can either use a pre-defined size (Full size, Half-screen, quarter size) or a custom size via the list item 'Other'.

Note that full size video requires a fast processor.

The option to clip the edges enables you to reduced the viewable area of the picture. This is helpful if you are watching a widescreen movie or the TV picture displays a line at the top (due to closed captioning).

Four presets enable you a quick access to the most common settings. A custom value can be entered by selecting 'Custom' in the presets.

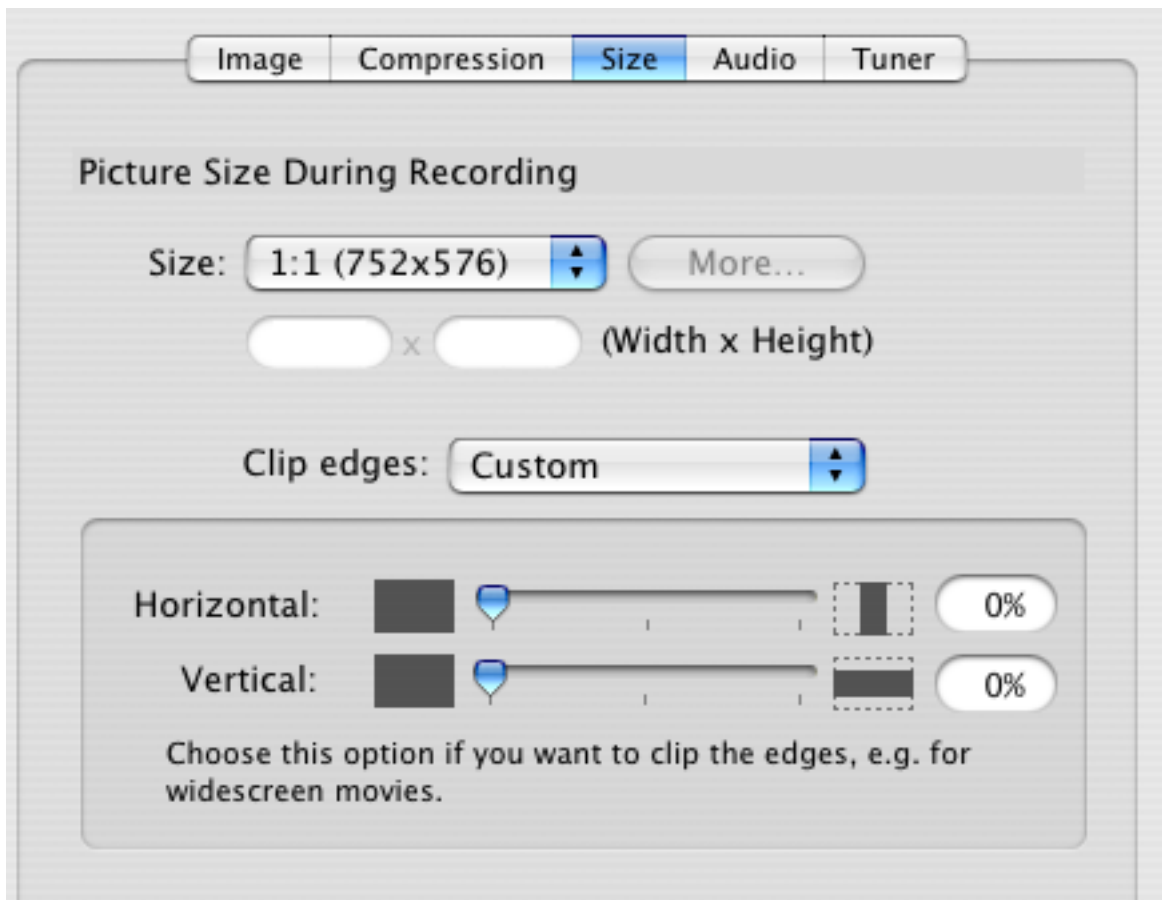

5. **The audio settings** enable you to control various audio settings of the video you will record to your hard drive. These settings will be applied to both scheduled recordings and the live TV window.

The Device list let's you select the desired input device, eg. AlchemyTV, the built-in motherboard audio or any other compatible USB or FireWire device.

If you are capturing via the TV tuner, AlchemyTV and TV Tuner are the correct settings.

If you are capturing via S-Video or Composite, the 'Audio-IN' on AlchemyTV or the audio IN on your motherboard are preferred.

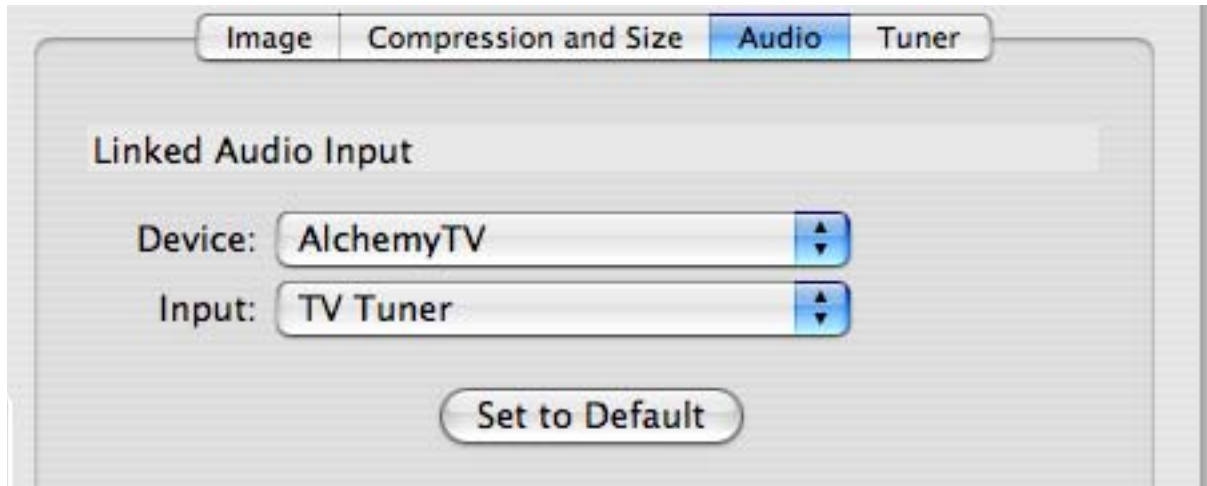

The basic audio settings for capture in the video input menu.

6. The **Audio Expert Settings** will give you a wider range of audio options via a standard QuickTime menu.

Speaker: This will usually be turned off as AlchemyTV does not use QuickTime for live audio playback. If the speaker is set to ON, the software will automatically revert it back to OFF.

Gain: This value can be adjusted to increase or decrease the audio volume on recordings. Live level feedback is also given.

Compression will determine what audio codec to use to compress the audio track. Note that with the current QuickTime version (6.5), it is recommended to leave this setting to none

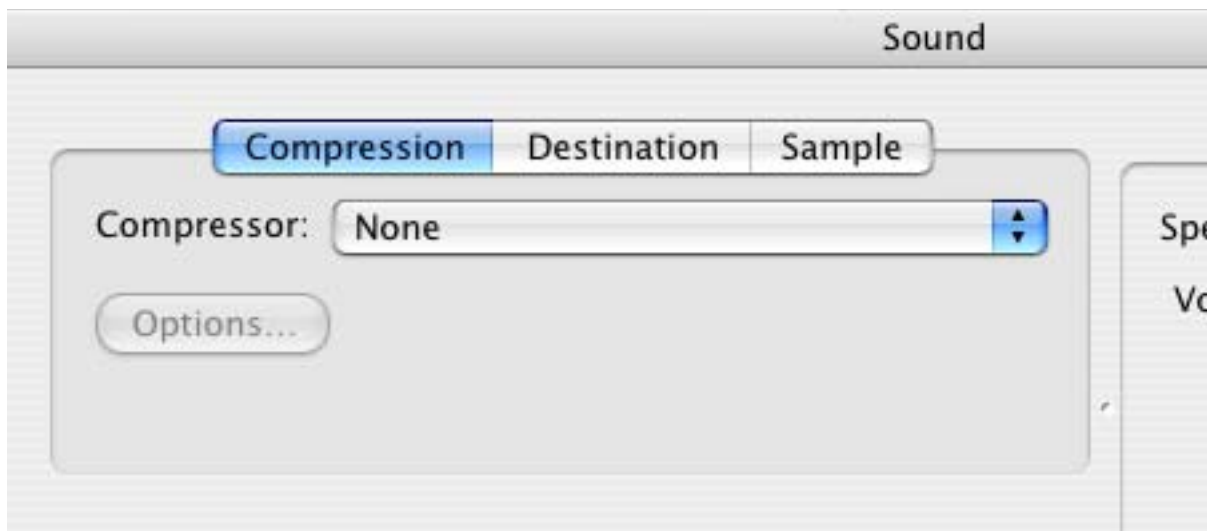

Destination controls the audio output of the recorded audio during live playback.

Internal: The internal speaker of your PowerMac or the speakers attached to it will be used

External: The speakers you may have connected to the audio out of the AlchemyTV card will be used. This can be used to pass-through the audio to another device.

Internal and

External: Both outputs will be used.

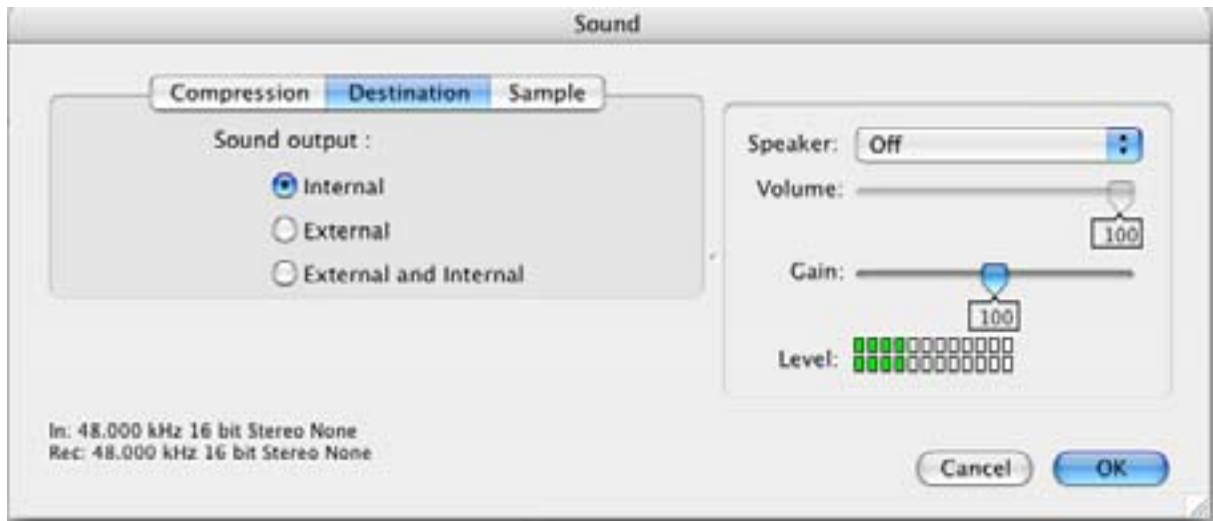

Sample controls the sample rate, the size and the mode (mono/stereo).

Note that the 48KHz setting is only available on the DVRPCI-SIL, DVRPCI-NTSC, TVPCI-SIL, TVPCI-NTSC models. The 'older' G4-only PAL/SECAM version of AlchemyTV does not support 48 KHz.

The best settings usually are: 48.000 kHz, 16 bits, Stereo.



8. The TV Tuner Sub-menu

The TV tuner sub-menu allows you to create and select channel layouts. It also enables you to scan and fine-tune channels manually, without the help of the Setup Assistant.

It is possible to create a **new channel setup without using the Setup Assistant**. To Do so, select 'Create from Template' in the drop-down menu. The selected pre-defined channel list can then be scanned and fine tuned.

Note: This will not be required if you already have setup AlchemyTV DVR with the Setup Assistant.

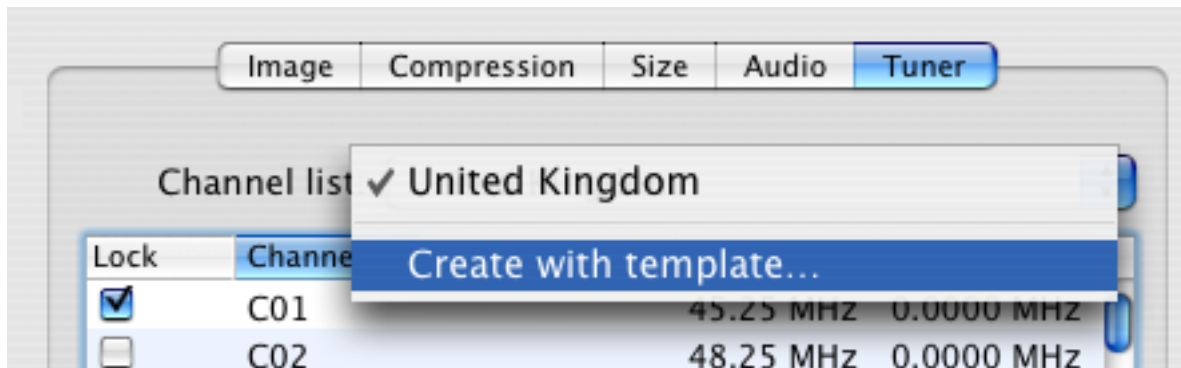

The Finetune button at the bottom of the window enables you to modify the frequency of a channel manually. You can also enter the frequency manually in "Base Frequency".

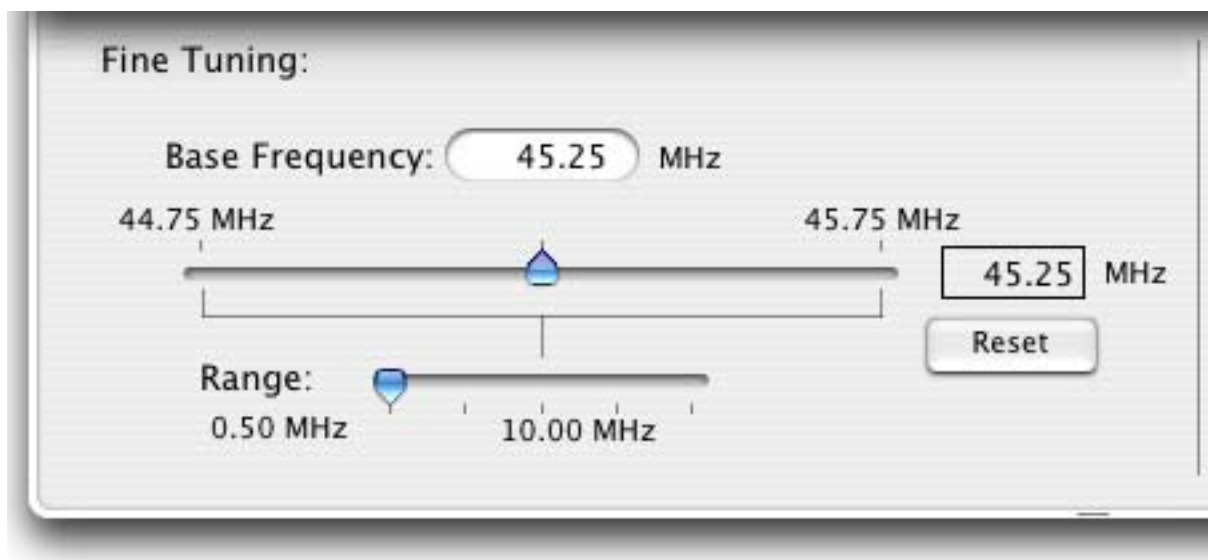

Channels can be renamed in the TV Tuner window by clicking on the 'Name' part of the window.

A **channel can be added or removed** by ticking the "Lock" box in the row it is displayed in.

III The Plugins Menu

AlchemyTV DVR supports a Plugins architecture allowing a smooth integration with third-party applications and devices.

The current **iCal plugin** can however be adjusted to import or export recordings via the 'Show Settings' button. The 'Export' function is activated by default.

You may want to check this menu with every update of the application, as plug-ins are added.

Third party plug-ins can be downloaded from the Miglia site (see the support page).

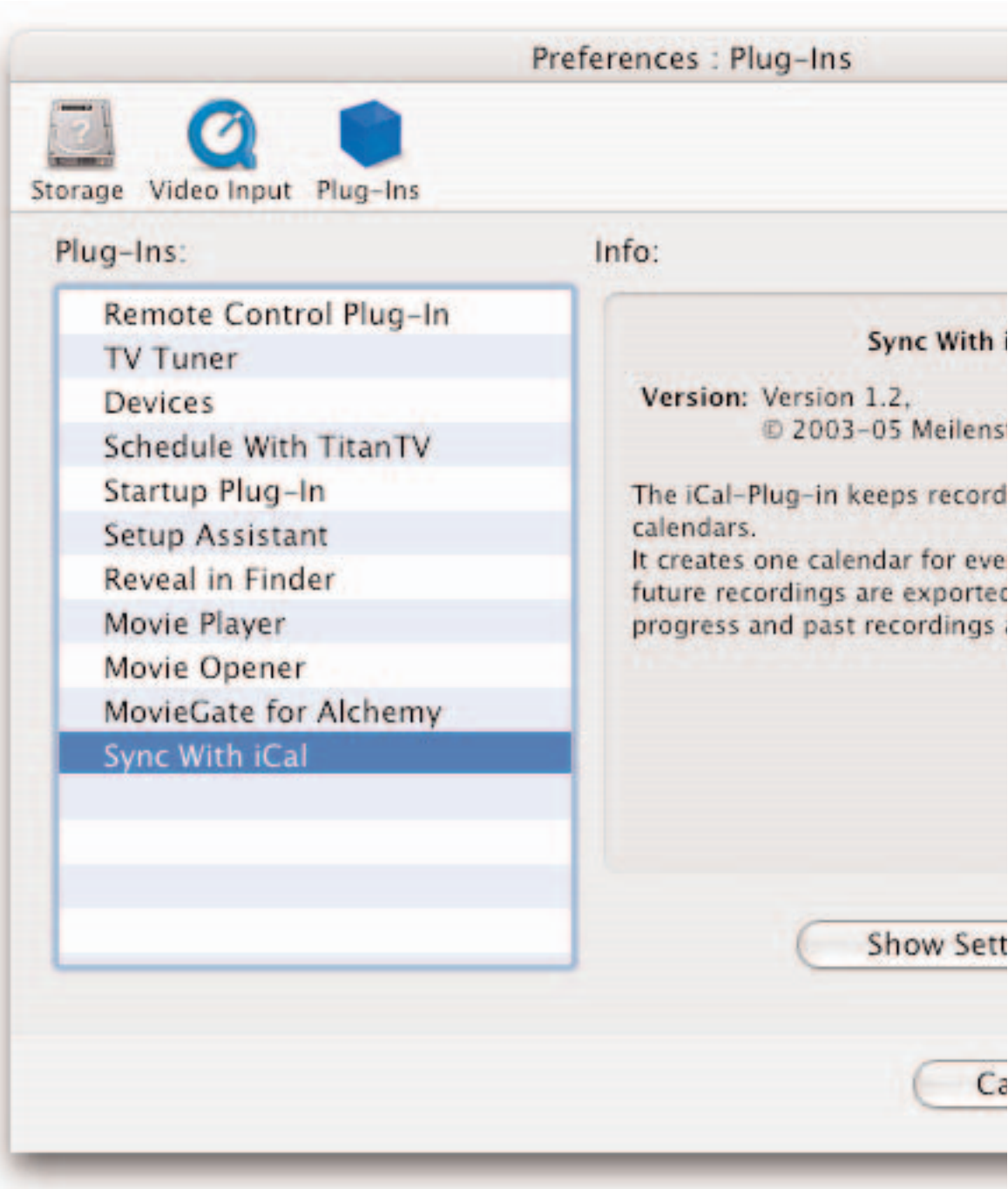

Scheduling a recording with AlchemyTV DVR

I. Schedule a recording with AlchemyTV DVR

1. Click on View > Show scheduled recordings.
2. In the 'Scheduled Recordings' window, click 'New Recording' to create a new recording.



The Scheduled Recordings window displays the various recordings you have programmed

3. Select your desired channel and enter the name of the program you wish to record (the name itself does not affect the recording. You can either use a Filename template or give a unique name to the recorded file. Time, date and repetition can be entered on the right side of the window.

You can also select the level of picture clipping for the recording

Click 'Add record' when you are finished.

In the case of repeated recordings, the application will automatically add an incremental number at the end of the file.

Scheduled Recordings

Date

Start: 3/24/05 3:30 PM

End: 3/24/05 5:00 PM

Duration: 1 h : 30 m

Don't repeat

Su Mo Tu We Th Fr Sa

Video Source

Device: EvolutionTV

Input: TV Tuner

Format: PAL

Channel: 23: BBC 1

Movie

Name: 23_BBC 1_Nature Use template

Program: Nature Use second language





Choose Folder... /Users/ericf/Movies

Cancel Add

4. Your new recording will be added to the 'Scheduled Recordings' list (see 2.). Note that AlchemyTV DVR will ask you for your administrator password when you schedule the first recording. This will activate the startup plug-in that controls the automatic startup/wake up features (Check the Plug-ins chapter for more information on the Startup Plug-in).



5. Scheduled recordings window list items:

- Status:** Displays the status of the recording via icons.
-  The recording is scheduled
 -  Performing a recording
 -  Recording is active and will be performed.
 -  Recording in progress

II.. iCal synchronisation

AlchemyTV DVR can synchronise your recordings with iCal. Make sure that the iCal plugin is set to import or export recordings, depending on your preference.

1. Export: Once you have created a recording in AlchemyTV DVR, it will appear as a separate calendar item in iCal.
2. Import: An iCal calendar item can be imported into AlchemyTV DVR, provided it follows the naming convention 'Channel :: Program'. For the 'Channel' Value, enter either the exact channel name that you defined (BBC1, ZDF, for example) or the channel location (C26, C44 for example). The "Program" value will be used for the filename.

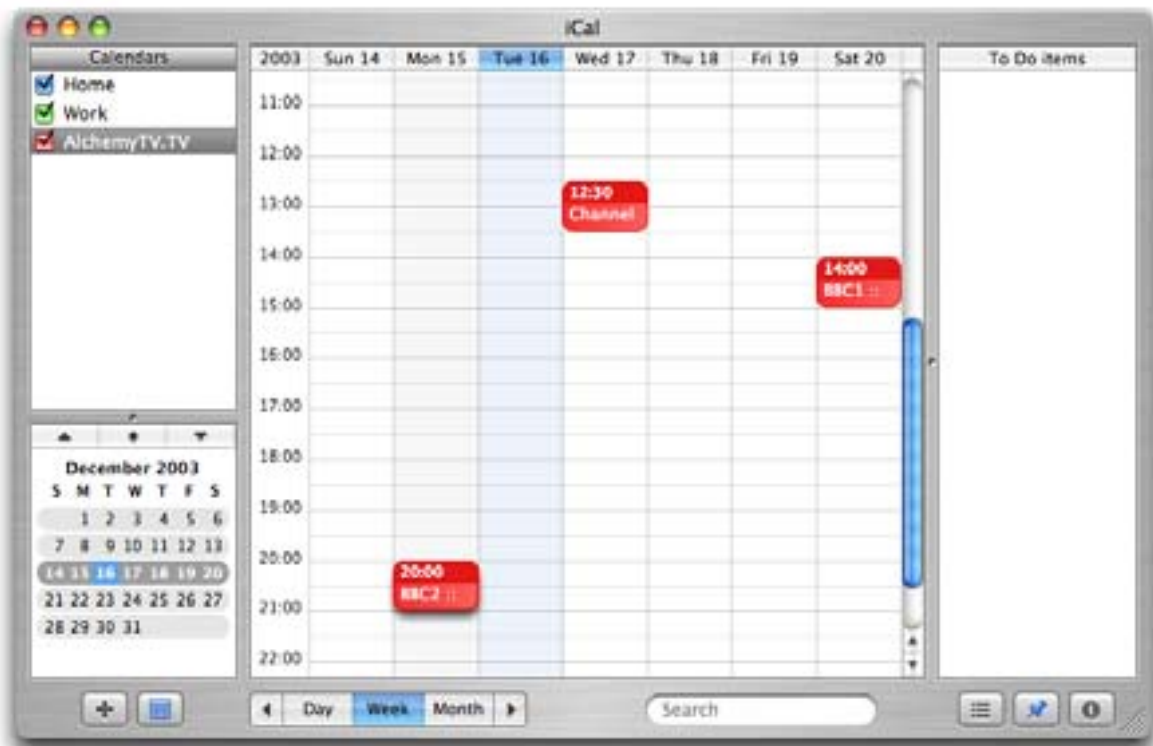

Recordings scheduled in AlchemyTV DVR are automatically shown in iCal

Scheduling a recording with TitanTV



Introduction

AlchemyTV DVR 2.2 and higher support Decisionmark's TitanTV EPG (Electronic Program Guide) to browse, search and schedule recordings. Note that TitanTV is only functional in the United States at the time of this writing.

I. Registering with TitanTV

In order to access the TitanTV program listings, you will first have to register online. Open your web browser and enter the address <http://www.titantv.com> Click on the "Sign up" button and follow the onscreen instructions to create an account.

II. TitanTV Plug-in Settings

TitanTV integration in AlchemyTV DVR is achieved via a plug-in, whose options are accessible via the plug-ins menu.

You can change the video input used by the TitanTV plug-in by clicking on 'Show Settings'. If you receive your TV channels via the TV Tuner, select 'AlchemyTV:TV Tuner:NTSC' as the input. If you use a cable or satellite receiver select either Composite or S-Video.

Note: If you are using a cable or satellite receiver, you will need to select the channel you wish to record from via the receiver's remote.

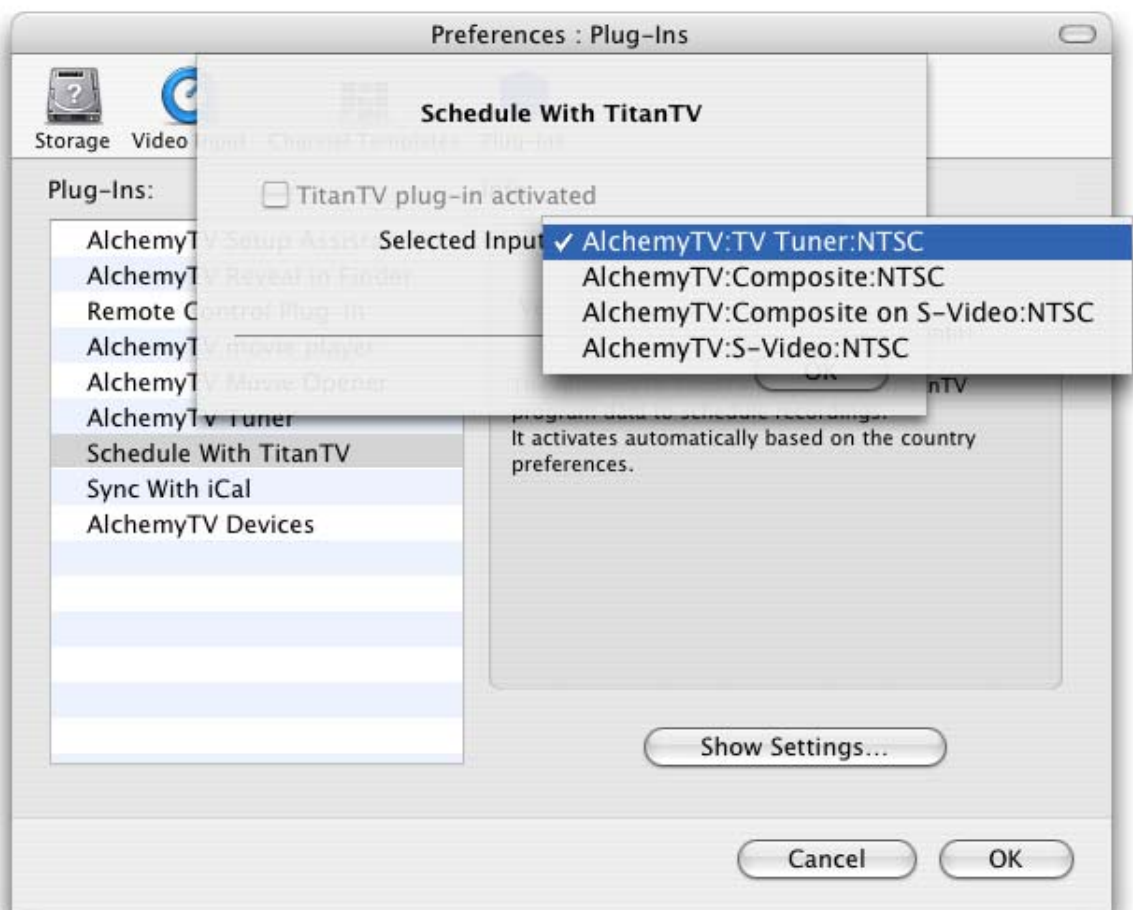

III. Scheduling a recording with TitanTV

1. Select 'TitanTV TV Listings' from the AlchemyTV DVR menu. This will launch your browser and redirect you to the TitanTV login page
2. Enter your username and password you created during TitanTV's sign up process.
3. You can now browse or search the local TV listings.
4. Each individual TV program has a detail window accessible through a hyperlink.

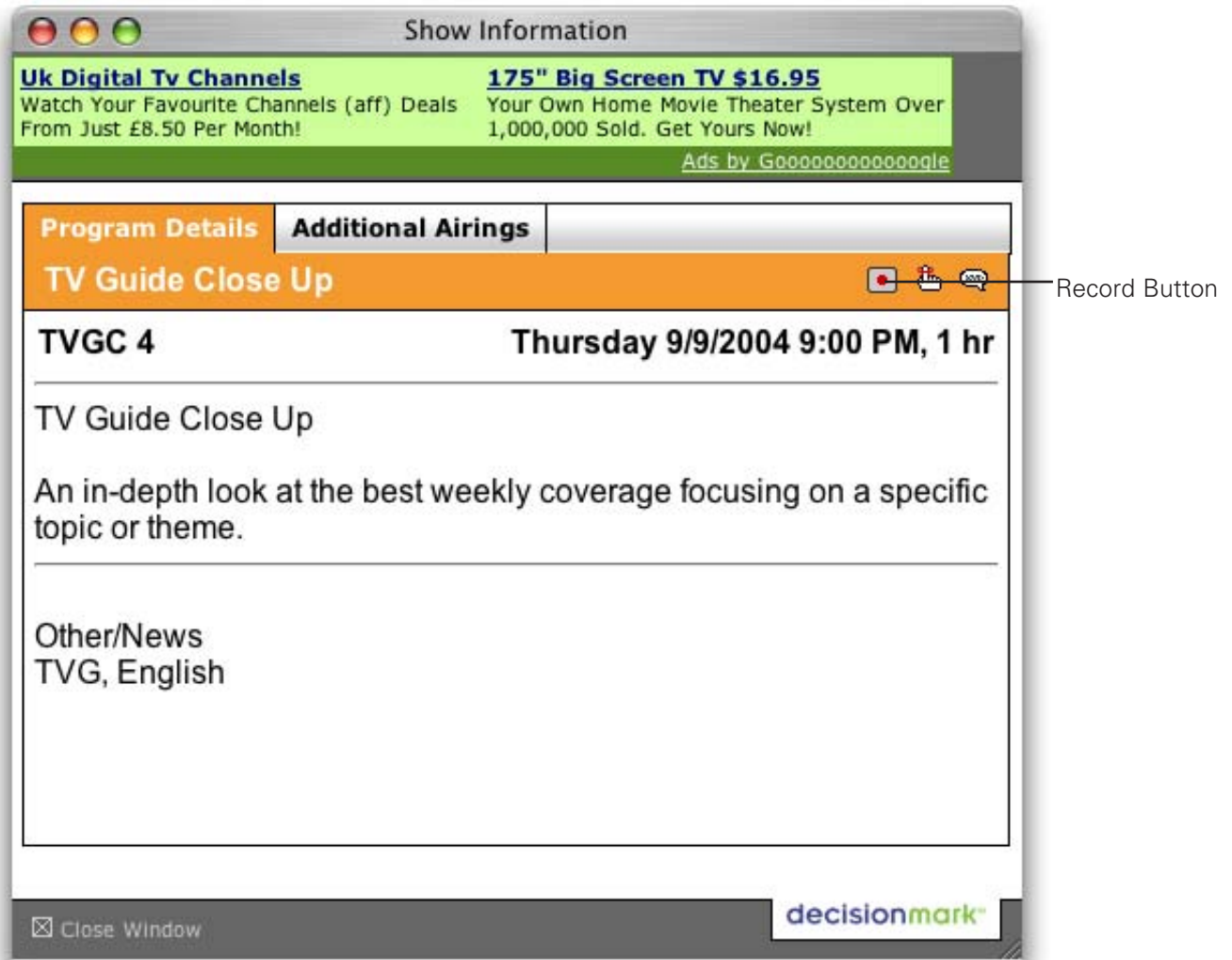

5. To schedule a recording, simply navigate to the detail window and click on the red record button. A file containing the scheduling information will be downloaded and opened in AlchemyTV DVR.

AlchemyTV DVR *Plug-ins*



Introduction

AlchemyTV DVR 2.1 and higher supports an open plug-in architecture that enables software developers to create enhancement modules.

The application ships with several built-in plug-ins. Further enhancements are provided by third party plug-ins that are usually free of charge and that can be downloaded from Miglia's website: http://www.miglia.com/Support/alchemytvdvr_plugins.html

I. AlchemyTV DVR SDK

A Software Development Kit (SDK) has been made available on Miglia's website. This SDK facilitates the creation of post-processing plug-ins, eg. plug-ins that will modify a file once it has been downloaded.

More information on the SDK is available on Miglia's website: http://www.miglia.com/Support/alchemytvdvr_sdk.html

II. Installing Third-party plug-ins

Before installing a plug-in, make sure that AlchemyTV DVR is not running.

2.1 Plug-ins with installers

Some plug-ins have installers, that work just like any other software installation program. You may be asked to enter your administrator password during the installation process.

2.2 Plug-ins without installers

If a plug-in does not have an installer, you will have to proceed to a manual installation.

Control-click on the AlchemyTV DVR application and select "Show package contents".

Navigate to Contents > PlugIns and drop the plug-in in the folder. Then restart AlchemyTV DVR.

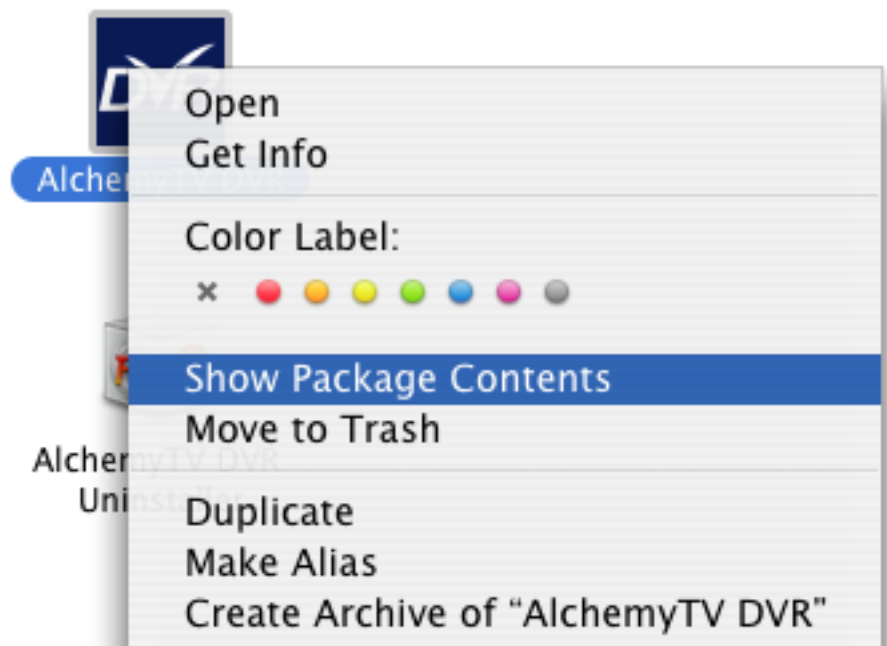

III. Using Third Party Plug-ins

3.1 Plug-in Settings

Plug-ins settings are available in Preferences > Video Input > Plug-ins > Show settings

Note that some plug-ins do not have any settings.

Explanation for the individual settings of a specific plug-in are usually included in the Read-me file included with a third party plug-in.

3.2 Using the plug-ins

Plug-ins currently only work with files recorded with the scheduling function. To access a plug-in, highlight a finished recording and select details. A drop down menu will give you access to the installed plug-ins.

Note: the recording must have been completed before you can use a plug-in.

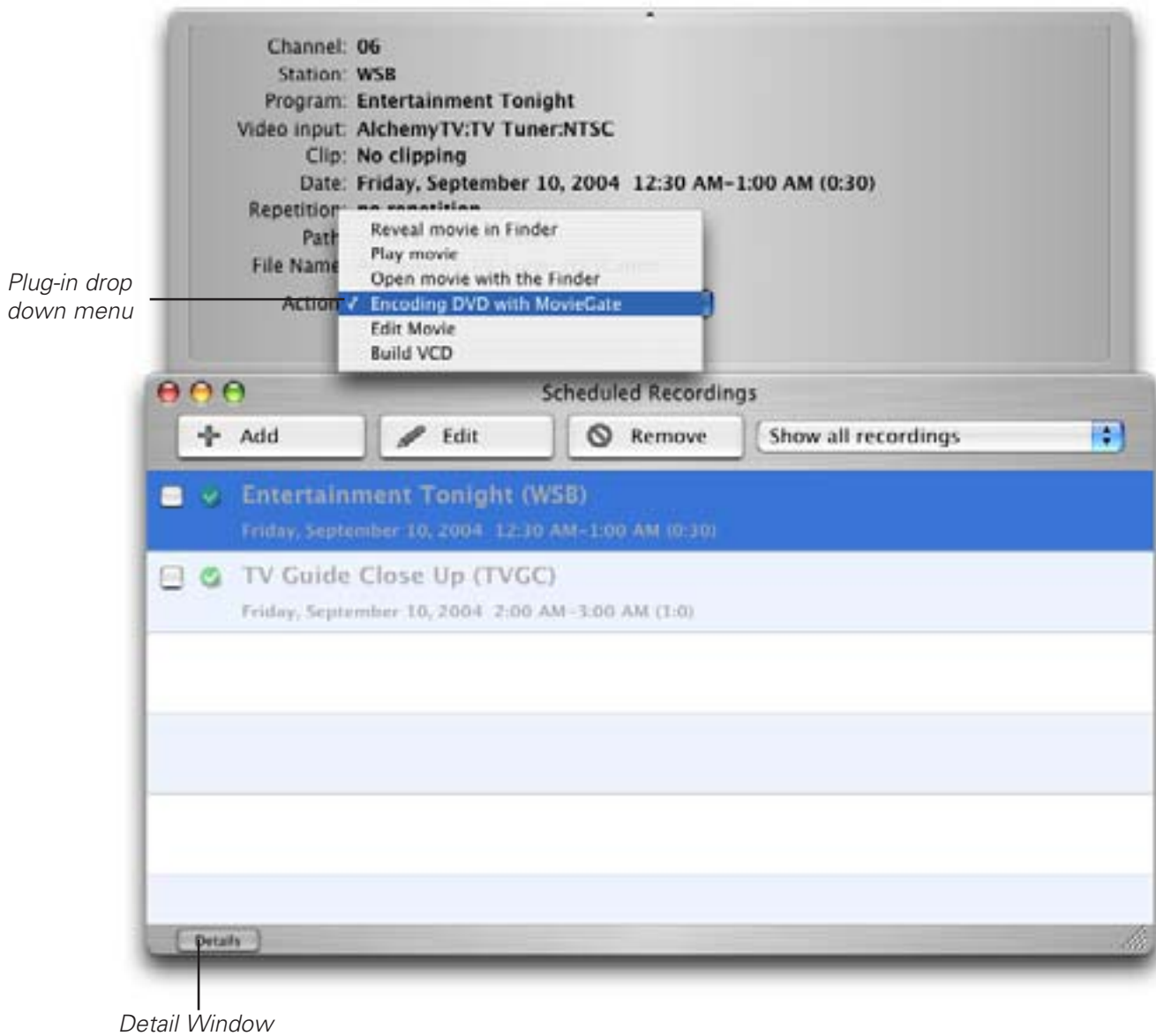

III. Current Plug-ins

3.1 Built-in Plug-ins

Interface Plug-in:

AlchemyTV Setup Assistant: Provides the Setup Assistant functionality to AlchemyTV DVR.

Post-Processing Plug-ins:

Reveal in Finder: Shows a recorded file in the Finder.

Movie Player: Enables you to play a recorded movie from within AlchemyTV DVR

Movie Opener: Lets you launch a movie file via the Finder. This will most likely open QuickTime Player

Device Plug-ins:

Devices: Provides the software link with the AlchemyTV PCI card

Tuner: Provides the software link with the AlchemyTV Tuner

Communication Plug-ins:

Remote Control Plug-in: Provides a link with the remote control software

iCal Plug-in: Enables you to import/export scheduled recordings to an iCal calendar. Recordings can be created in iCal and sent automatically to AlchemyTV DVR.

User Options:

Export recordings: Recordings created with DVR will be automatically sent to iCal

Import recordings: Recordings created with iCal will be automatically sent to AlchemyTV DVR

Schedule with TitanTV: Provides the TitanTV web scheduling functionality. Note that this plug-in is activated by default if USA is selected as a country by the Setup Assistant.

User Options:

Video Input: Lets you select the video input for TitanTV recordings.

Startup Plug-in: Provides automatic startup/wake up functionality to the application when a recording is due to start.

User Options:

Startup delay: Lets you select the amount of time between the startup/wake up command and the beginning of the recording.

Shutdown: Enables automatic shutdown once the scheduled recording is finished.

3.2 Third-Party Plug-ins

Post-Processing Plug-ins:

MovieGate for Alchemy: Enables you to create a VCD, S-VCD or DVD from a recorded file. This plug-ins includes conversion to MPEG-1 or MPEG-2, DVD chapter creation, VCD, S-VCD and DVD burning. A read-me file included in the disk image provides instructions.
Written by: Christophe Ducommun, Ludovic Paquot, Jean-Bernard Jovelet

DivTV: Enables you to create VCD and S-VCD disk images ready for burning. Includes MPEG-1 and MPEG-2 software conversion of recorded files.
Written by: Fabio Verna

DVR Editor: Allows you to perform some basic editing on recorded files, like removing adverts and cutting scenes. It is a handy and free-of-charge replacement for QuickTime Pro's editing capabilities.
Written by: Jakob Weick

Other Enhancements:

DVR Mail Action: DVR Mail Action is an Apple Script enabling you to schedule a recording via e-mail. DVR Mail Action uses iCal to pass along the scheduling information to AlchemyTV DVR

DVR Clicker: AlchemyTV Clicker lets you control AlchemyTV and AlchemyTV DVR with Salling Clicker

The infrared remote control

I. The Remote Control Settings

1. Open System Preferences > Remote. The 'Remote' item is located at the bottom of the System Preferences panel in the 'other' section.
2. The Remote Control software translates the key you press on the IR remote into key combinations that are sent to the applications or operating system. The 'key maps' can be customised for any given application via the control panel. You will notice the 'AlchemyTV' item on the left side of the screen. By clicking on it, the appropriate key combinations are displayed in the right column.

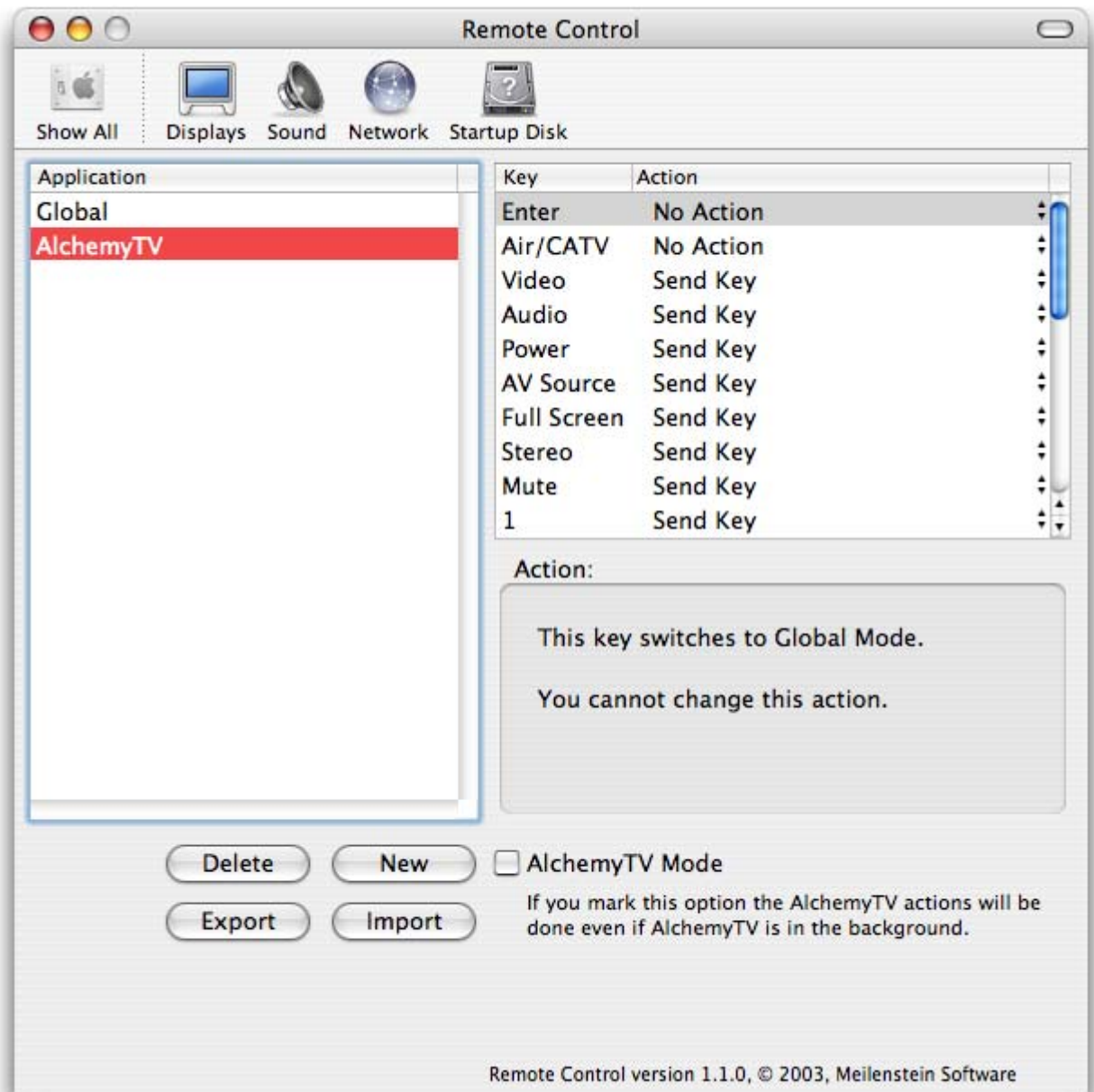

The Remote control panel allows you to set 'key maps' for a given application

- You can control most applications that run on your Mac by adding a key map for them in the control panel. Click on 'New' at the bottom of the screen, select the desired application and the possible key mappings will appear on the right hand side of the screen.

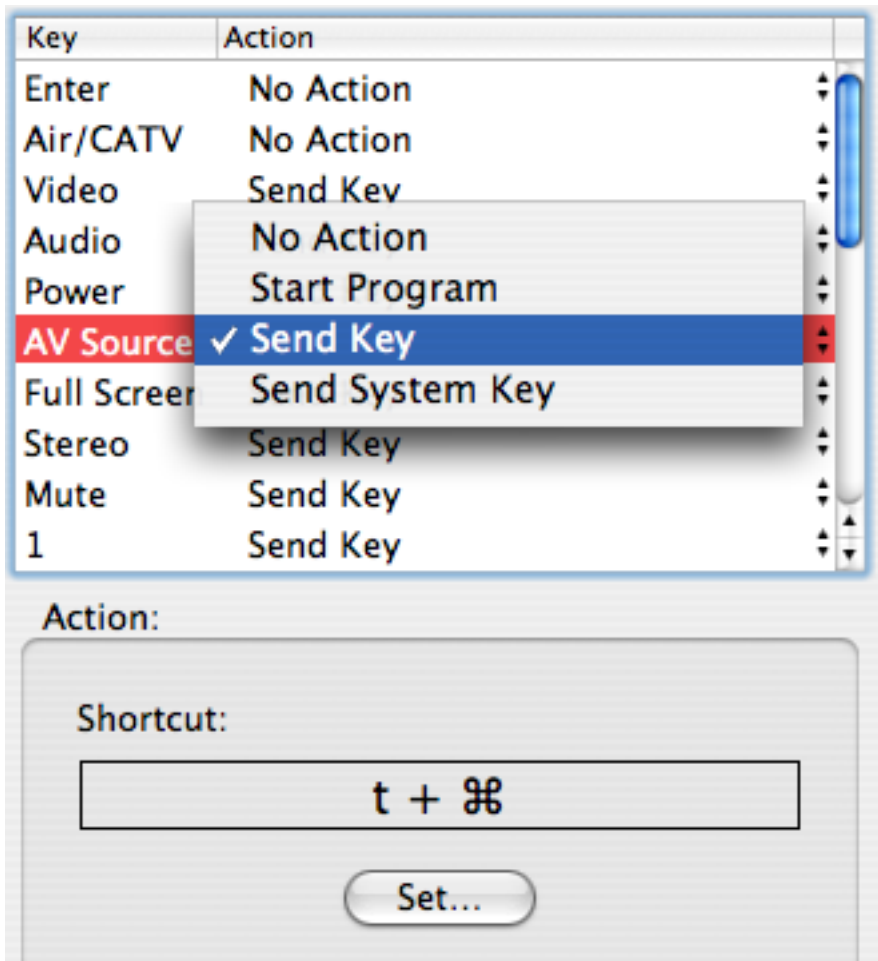

- By clicking on the 'Set...' button in the Action section, you can assign a specific key combination to a button on the remote.

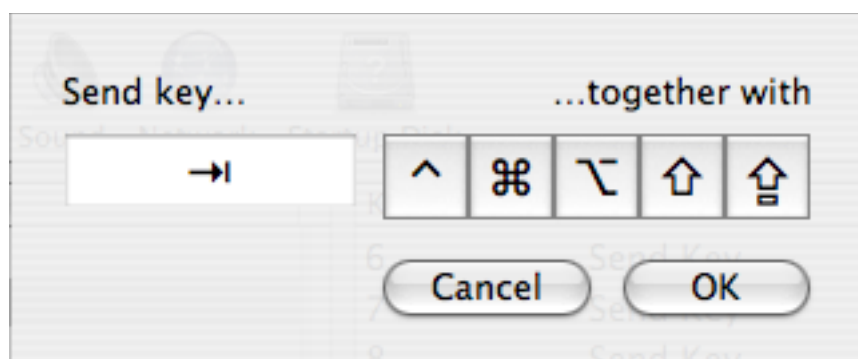

- The 'Global' key mappings control the Finder.
- Key mappings can be exported/imported using the 'Export' and 'Import' buttons at the bottom of the screen.

Example: How to setup the Remote Control for iTunes

1. Select "New" and browse to the folder where iTunes is located (usually in Startup drive > Applications). Press OK to create a new key mapping for iTunes.

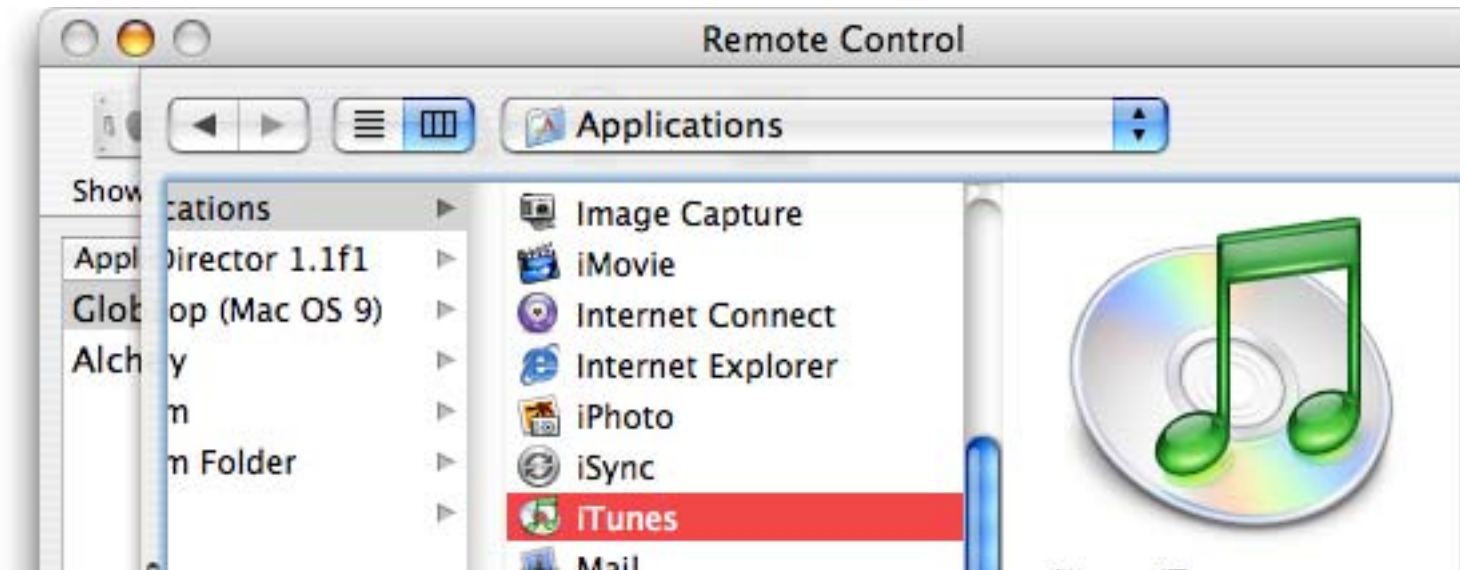

2. Scroll down the window displaying the key assignments until you find 'Vol +'. Highlight this line and click on the highlight column (displaying 'no action'). A drop down menu will appear giving you access to a drop down menu. Select 'Send key'

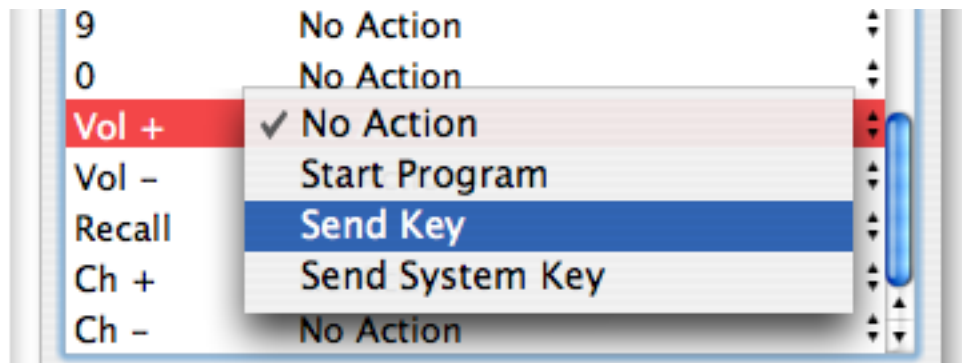

3. Click on 'Set...' in the Action window to create the shortcut. In the keyboard shortcut window, click on the 'Apple key' and press arrow up on your keyboard. Then click OK. If you press the 'Vol +' button, the volume in iTunes will be increased. Repeat the operation above to set the volume down key combination ('Apple key' and Arrow down on your keyboard).

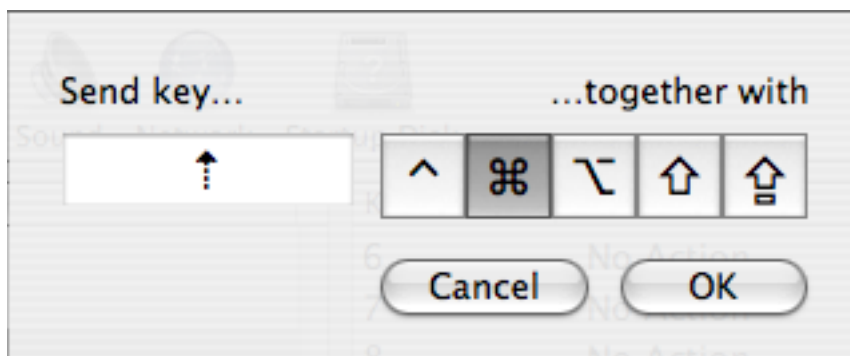

4. The menus of iTunes, or most other applications, will show you what kind of shortcuts you can choose.

QuickTime Codecs

I. QuickTime Codecs

AlchemyTV DVR relies on QuickTime to perform the encoding of your video footage. All codecs that are accessible in QuickTime are accessible in AlchemyTV (export codecs are not included).

Some codecs should not be used with AlchemyTV, as they have been designed for other types of applications, but many are useable.

The recommended codecs for capture with the AlchemyTV are Motion-JPEG and MPEG-4.

Motion JPEG: This codec has some fairly large space requirements, but has the advantage of requiring less processing power to encode (eg. record) and remains editable in some video applications. You can for example open a MJPEG video in Final Cut. You can also do some basic editing (cut the adverts out of your recorded programme, for example) with QuickTime Pro. There is no difference of any major consequence between the two versions of MJPEG with regards to their use with AlchemyTV DVR.

MPEG-4: The MPEG-4 codec requires more processing power, but requires less hard drive space to be recorded. Editing with MPEG-4 files is limited to cutting sequences. MPEG-4 has a quality setting that will greatly influence the size of the resulting video. It is recommended that you reduce the screen size to save additional drive space.

DV-NTSC

DV-PAL: DV-25 is the codec used by most Digital Cameras. AlchemyTV DVR does not feature any DV-hardware encoder and may provide mixed results. This format is directly readable by iMovie using the import function.

Cinepak: Cinepak was the 'native' standard compression codec of QuickTime until release 3.0. Although fairly fast at encoding, it produces lower quality files with a rather large size.

None: No compression will be applied. This creates extremely large files.

You can attempt to use other codecs, but this might result in dropped frames or the inability to record video at all.

Third party codecs include DivX and 3ivX, which are quite similar to MPEG-4.

DivX: You can download a DivX codec installer from <http://www.divx.com>. DivX requires an extremely fast processor (G4//1.25 GHz) to get good results with a half screen size. The files will be very compact without affecting the quality. Full screen recording is not possible even on a Dual 2GHz G5 (unless you have no minimum expectations in terms of quality!) It is essential to create a profile in the advanced settings of the DivX codec to perform successful recordings.

3ivX: You can download a 3ivX codec installer from <http://www.3ivx.com>. A Mac version is also available. This codec uses less processing power than DivX and creates small file size too. Full screen recording is an issue even on the fastest G5 processor.

The use of third-party codecs is not yet supported by Miglia Technology !

License Agreement

This license contract is part of the purchase contract. The conditions for the use of the AlchemyTV™-software are written down in the following license contract. With the use of the AlchemTV™-software you agree to the conditions of the license contract for the use of the AlchemyTV™-software. A special note to Miglia technology ltd or its traders is not necessary. If you do not agree with the conditions of the license contract, do not use the software and immediately return the package against full repayment to the place of purchase.

1. License Transfer

1.1 Miglia Technology Ltd(in the following Miglia) herewith gives you the right to use the Alchemytv™-software including all updates (in the following software) and its documentation.

1.2 Miglia reserves all rights concerning the software, only the CD containing the software is becoming your property.

1.3 The license software gives you the right for use on no more than one computer each as well as the making of one copy of the software in machine readable form exclusively for safeguarding purposes.

1.4 You are not entitled to sell the software to a third person or leave it otherwise in a third person's possession, except if this person promises Miglia in writing to observe the conditions of this license contract. This also applies to the master copies.

1.5 You are obliged to refrain from using the software other than expressly mentioned in this contract.

2. Restrictions

The software contains company secrets. To safeguard these secrets you are not allowed to decompile, redevelop or disassemble the software or otherwise bring it into a form that is recognisable by a person. You may not modify the software, adapt, translate or sell it or otherwise leave it to be used by third persons for money or not or develop devices that are completely or partly derived from the software. Finally, it is forbidden to electronically transfer the software onto another computer.

3. Cancellation

This license automatically loses its effectiveness, without the need of a notice, if you offend against one of the regulations of this contract. In this case you are obliged to destroy the software and all copies. You can also cancel this license contract any time by destroying the software and all copies.

4. Export Ban

It is your liability to see to it that the software is only exported into an-other country under strict observance of all applicable export regulations.

5. Guarantee

5.1 Errors in the software and the documentation belonging to it cannot be excluded. Miglia is liable only within the limits of the legal regulations. Characteristics of the software that all copies of the delivered ver-sion of the software have and which therefore are typical for the delivered version are not included in the guarantee; especially a right to the delivery of a newer version cannot be sustained by the existence of such charac-teristics.

5.2 Possible defects of the software – including material and production faults or the disks – as far as being or becoming obvious have to be re-ported in writing to the authorized trader within two weeks after noticing the defect, however no later than within the legal expiry date of six months.

5.3 Should the software be faulty, the original CD on which the software is memorized has to be properly packed and returned to the authorized trader. In every case the complaint about the software has to be made by including your name, address, telephone number and a description of the defect and the system configuration.

5.4 Miglia reserves the right to decide if repairing or replacing the faulty software grants the possible guarantee. If the repair and / or replacement are not successful, you can choose between a deduction and a cancellation of the contract.

5.5 Unless an alteration, extension or damage is not the cause for the defect, no guarantee is granted for software that has been altered, extended or damaged.

5.6 In the case of an unfounded complaint, you are obliged to refund to Miglia the expenses resulting from the check-up.

6. Damages

6.1 A contractual or extra-contractual duty to pay for damages exists for Miglia or his representatives only if

a) the damage is due to total negligence or the missing of a promised quality of the software or deliberately caused,

b) a fundamental duty was at least slightly neglected by Miglia or

c) Miglia is liable due to compelling legal regulations based on the producers' or product liability.

6.2 In the case of Miglia being liable, according to the former para-graph b) for slight negligence, the following applies: Miglia's liability for indirect damages and damages following a defect and missed profits is excluded.

The liability is at least limited to the fortune disadvantage that Miglia should have foreseen as a possible consequence of contract infringement when signing the contract under consideration of the circumstances that Miglia had known or should have known. There is no guarantee for the loss of data except if this loss could not have been avoided by regularly saving the data in machine-readable form daily saving for business transactions. Furthermore, no liability is taken for damages that are caused by other defects of the software that could have been avoided by a regular, timely check of the processed work.

6.3 As long as damages do not expire earlier, according to the legal regulations they expire – with the exception of claims resulting from illegal action and founded on the law of product liability – at the latest after a period of two years after reception of the faulty device.

7. Final Regulations

This license contract and its interpretation are subject to German legislation. This license contract contains the complete agreement between the parties concerning the object of the contract.

Amendments and additions of this contract are only effective in written form. Ineffective regulations are replaced by effective regulations that come closest to the desired economical success.